

RICAMBI - SPARE PARTS - PIECES DETACHEES

LAVABICCHIERI

GLASSWASHERS

LAVE VERRES

JOLLY T - JOLLY Q - JOLLY AT - JOLLY AQ

J35 - J36 - JA35 - JA36

J350 - J360 - JA350 - JA360



LAVASTOVIGLIE - DISHWASHERS - LAVE VAISSELLE - GESCHIRRSPUELER - LAVAPLATOS

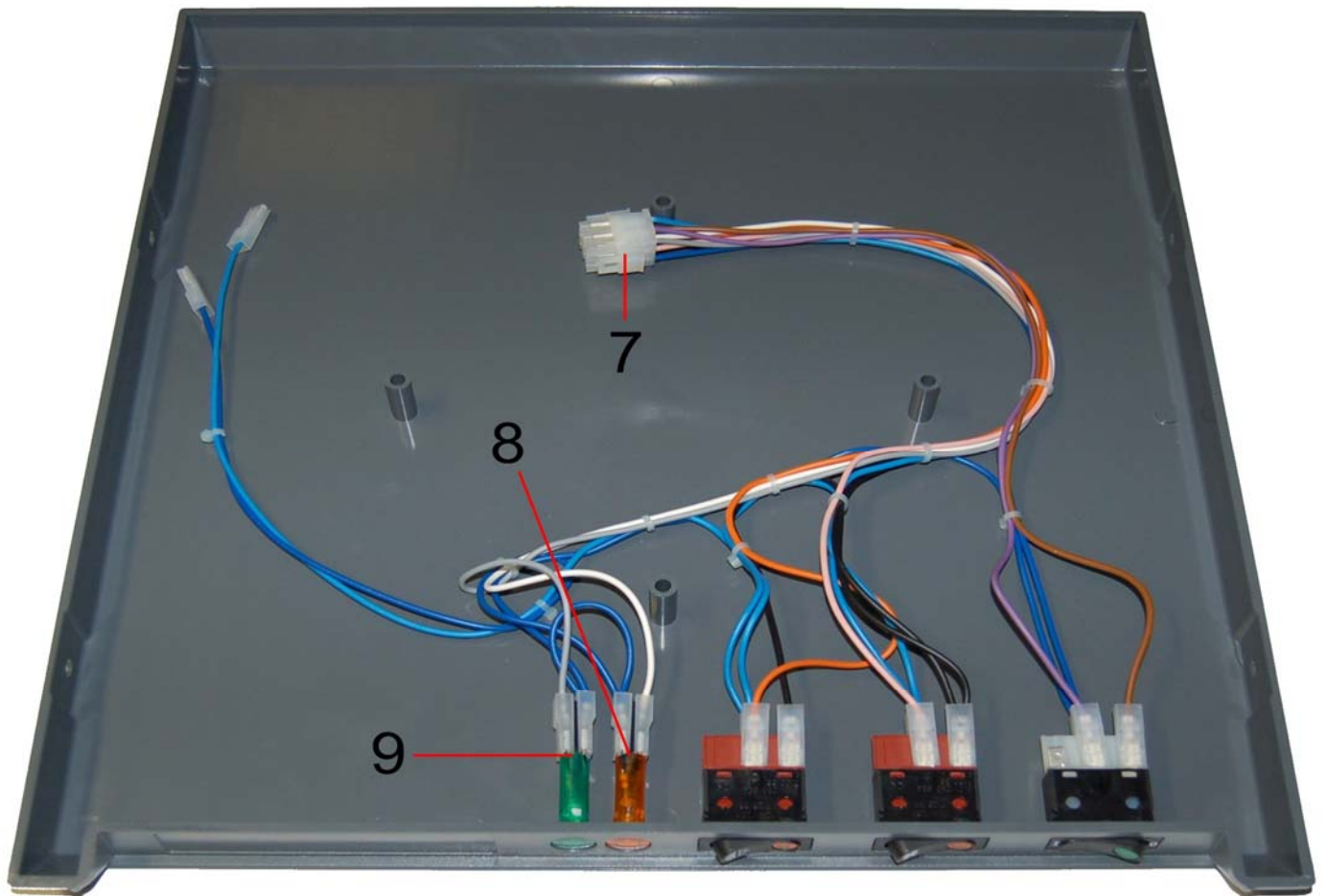
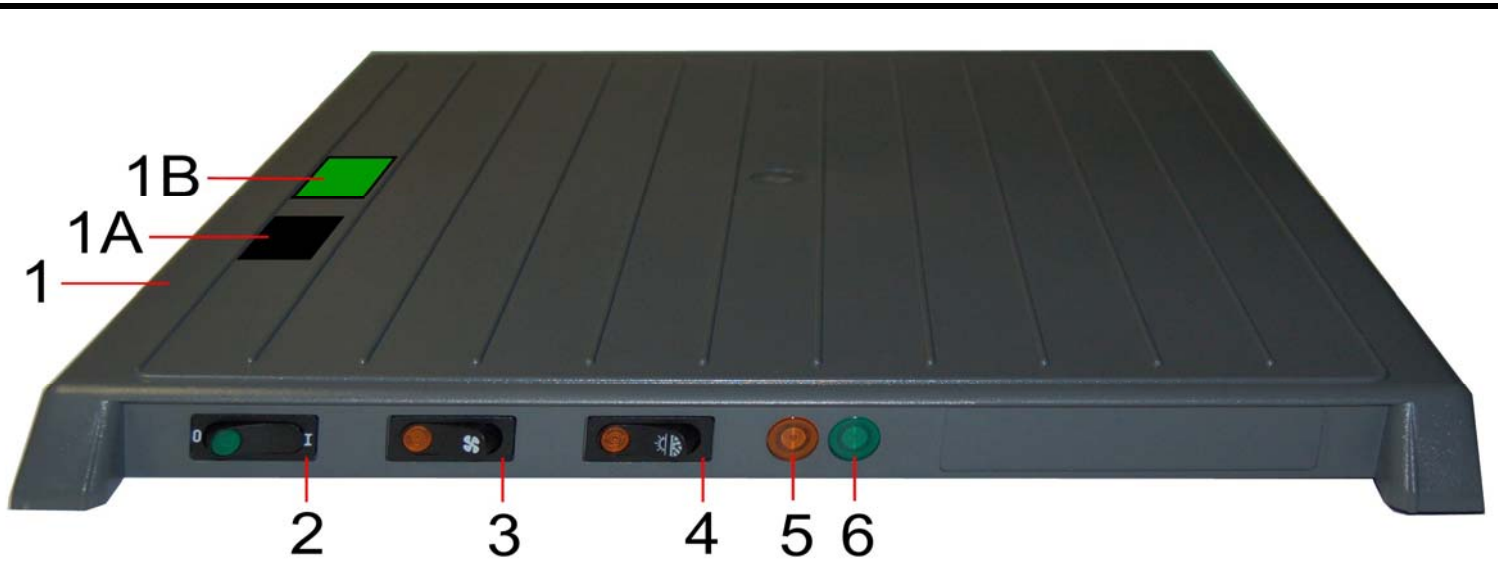

Pos.	Codice	Descrizione	Description	Description
1	GMPS1CSPLGR	Pannello superiore grigio	Top panel, ABS, grey	Panneau supérieur, gris
1A	GMPS1CSPL	Pannello superiore nero	Top panel, ABS, black	Panneau supérieur, noir
1B	GMPS1CSPLV	Pannello superiore verde	Top panel, ABS, green	Panneau supérieur, vert
2	CEIN3012	Interruttore 0-1	"ON-OFF" switch	Interrupteur "ON-OFF"
3	CEPUC3012	Pulsante ciclo	Cycle start switch	Bouton "Depart cycle"
4	CEPUR3012	Pulsante risciacquo freddo	Rinse push button	Bouton "Rinçage froid"
5	CESPE32	Gemma arancio	Cover, orange	Voyant orange
6	CESPE31	Gemma verde	Cover, green	Voyant vert
7	CECBSPCCS	Cablaggio superiore	Upper loom	Cablage supérieur
8	CESP27	Spia arancio	Warning light, orange	Ampoule voyant, orange
9	CESP27V	Spia verde	Warning light, green	Ampoule voyant, vert

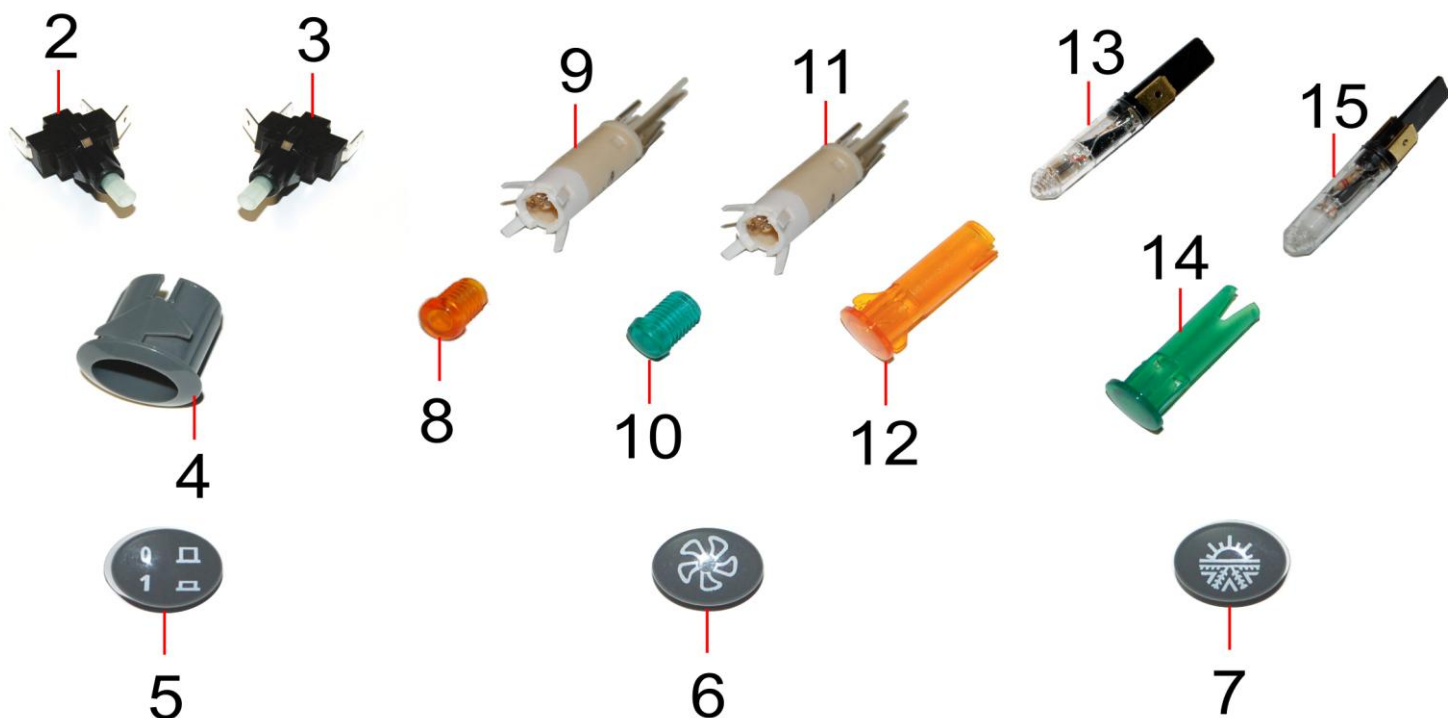

Pos.	Codice	Descrizione	Description	Description
1	GMPS1CSPLGR08	Pannello superiore Jolly grigio (2008)	Top panel, grey , mod Jolly (2008)	Panneau superieur, Jolly, gris
2	CEPUD08	Pulsante push CM (2008)	Inner switch body, latched, CM (2008)	Bouton CM (2008)
3	CEDPU08	Deviatore push CM (2008)	Inner switch body, momentary, CM (2008)	Deviateur CM (2008)
4	CETPD16GR	Supporto tasto ellittico grigio	Holder for switch body, grey (2008)	Support bouton elliptique gris
5	CETPED16G01	Tasto ellittico grigio "0-1"	Switch function insert, 1-0, grey	Bouton elliptique gris "0-1"
6	CETPED16GPC	Tasto ellittico grigio "Partenza ciclo"	Switch function insert, cycle, grey	Bouton elliptique gris depart cicle
7	CETPED16GRF	Tasto ellittico grigio "Risciacquo freddo"	Switch function insert, cold rinse, grey	Bouton elliptique gris rinçage froid
8	CEGA6	Gemma arancio 6mm	Lens, orange, 6mm	Voyant orange, 6mm
9	CESPA6	Lampada arancio 6mm	Lamp body c/w bulb, 6mm, orange, 230v	Ampoule orange, 6mm
10	CEGV6	Gemma verde 6mm	Lens, green, 6mm	Voyant vert, 6mm
11	CESPV6	Lampada verde 6mm	Lamp body c/w bulb, 6mm, green, 230v	Ampoule verte, 6mm
12	CESPE32	Gemma arancio	Combined lens & bulb holder, orange, 14mm	Voyant orange
13	CESP27	Spia arancio	Bulb, orange, 230v	Ampoule voyant, orange
14	CESPE31	Gemma verde	Combined lens & bulb holder, green, 14mm	Voyant vert
15	CESP27V	Spia verde	Bulb, green, 230v	Ampoule voyant, vert

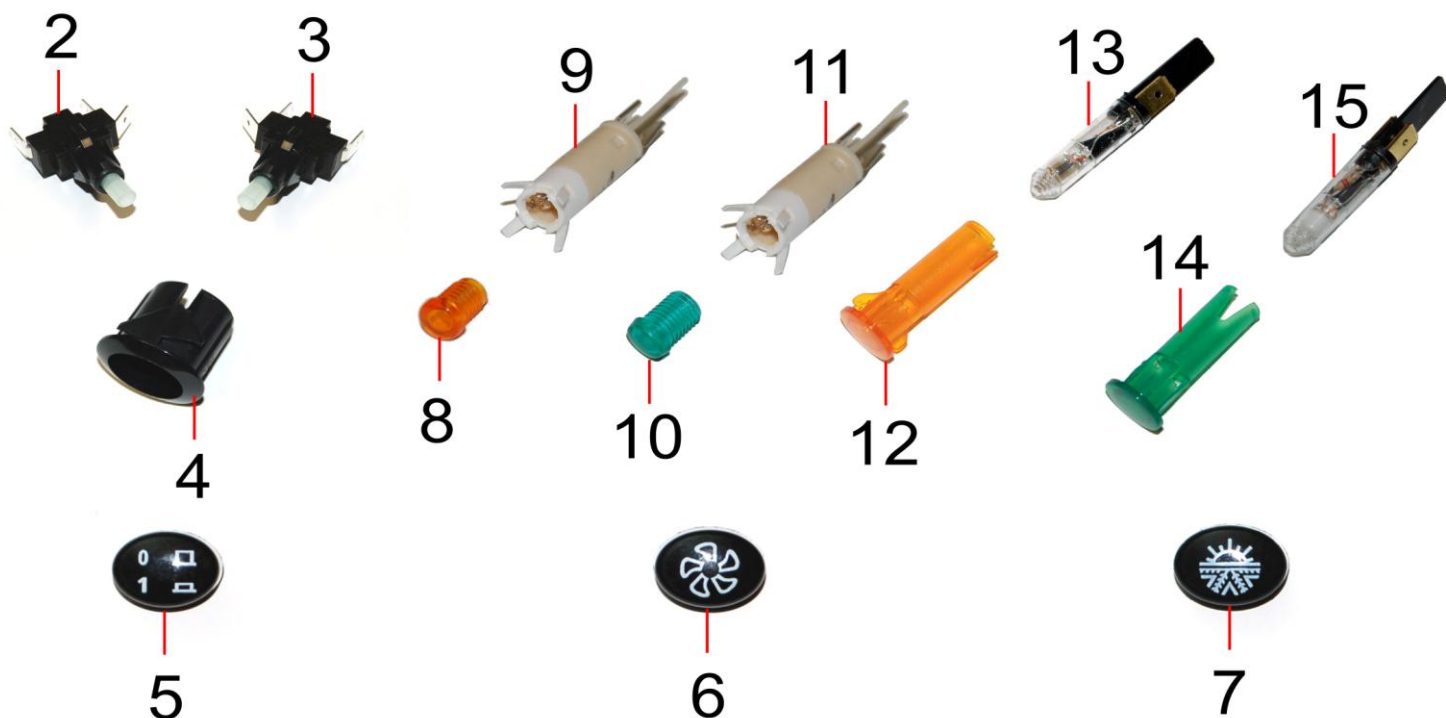

Pos.	Codice	Descrizione	Description	Description
1	GMPS1CSPL08	Pannello superiore Jolly nero (2008)	Top panel, black, mod Jolly (2008)	Panneau superieur, Jolly, noir (2008)
2	CEPUD08	Pulsante push CM (2008)	Inner switch body, latched, CM (2008)	Bouton CM (2008)
3	CEDPU08	Deviatore push CM (2008)	Inner switch body, momentary, CM (2008)	Deviateur CM (2008)
4	CETPD16N	Supporto tasto ellittico nero	Holder for switch body, black (2008)	Support bouton elliptique noir
5	CETPED16N01	Tasto ellittico nero "0-1"	Switch function insert, 1-0, black	Bouton elliptique noir "0-1"
6	CETPED16NPC	Tasto ellittico nero "Partenza ciclo"	Switch function insert, cycle, black	Bouton elliptique noir depart cicle
7	CETPED16NRF	Tasto ellittico nero "Risciacquo freddo"	Switch function insert, cold rinse, black	Bouton elliptique noir rinçage froid
8	CEGA6	Gemma arancio 6mm	Lens, orange, 6mm	Voyant orange, 6mm
9	CESPA6	Lampada arancio 6mm	Lamp body c/w bulb, 6mm, orange,230v	Ampoule orange, 6mm
10	CEGV6	Gemma verde 6mm	Lens, green, 6mm	Voyant vert, 6mm
11	CESPV6	Lampada verde 6mm	Lamp body c/w bulb, 6mm, green, 230v	Ampoule verte, 6mm
12	CESPE32	Gemma arancio	Combined lens & bulb holder, orange, 14mm	Voyant orange
13	CESP27	Spia arancio	Bulb, orange, 230v	Ampoule voyant, orange
14	CESPE31	Gemma verde	Combined lens & bulb holder, green, 14mm	Voyant vert
15	CESP27V	Spia verde	Bulb, green, 230v	Ampoule voyant, vert



Pos.	Codice	Descrizione	Description	Description
1	GMPS1CSN08	Pannello superiore 1 inox (2008)	Top panel 1 (2008)	Panneau supérieur 1 (2008)
2	CEDPU08	Deviatore push CM (2008)	Inner switch body, momentary, CM(2008)	Deviateur CM (2008)
3	CEPUD08	Pulsante push CM (2008)	Inner switch body, latched, CM (2008)	Bouton CM (2008)
4	CESPA6	Lampada arancio 6mm	Lamp assy, 6mm, orange	Ampoule orange, 6mm
5	CEGA6	Gemma arancio 6mm	Lens, orange, 6mm	Voyant orange, 6mm
6	CESPV6	Lampada verde 6mm	Lamp assy, 6mm, green	Ampoule verte, 6mm
7	CEGV6	Gemma verde 6mm	Lens, green, 6mm	Voyant vert, 6mm
8	CETPD16GR	Supporto tasto ellittico grigio	Holder for switch body, grey (2008)	Support bouton elliptique gris
9	CETPED16G01	Tasto ellittico grigio "0-1"	Switch function insert, 1-0, grey	Bouton elliptique gris "0-1"
10	CETPED16GPC	Tasto ellittico grigio "Partenza ciclo"	Switch function insert, cycle, grey	Bouton elliptique gris depart cycle
11	CETPED16GRF	Tasto ellittico grigio "Risciacquo freddo"	Switch function insert, cold rinse, grey	Bouton elliptique gris rinçage froid
12	CESP27	Spia arancio	Warning light, orange	Ampoule voyant, orange
13	CESPE32	Gemma arancio	Cover, orange	Voyant orange
14	CESP27V	Spia verde	Warning light, green	Ampoule voyant, vert
15	CESPE31	Gemma verde	Cover, green	Voyant vert

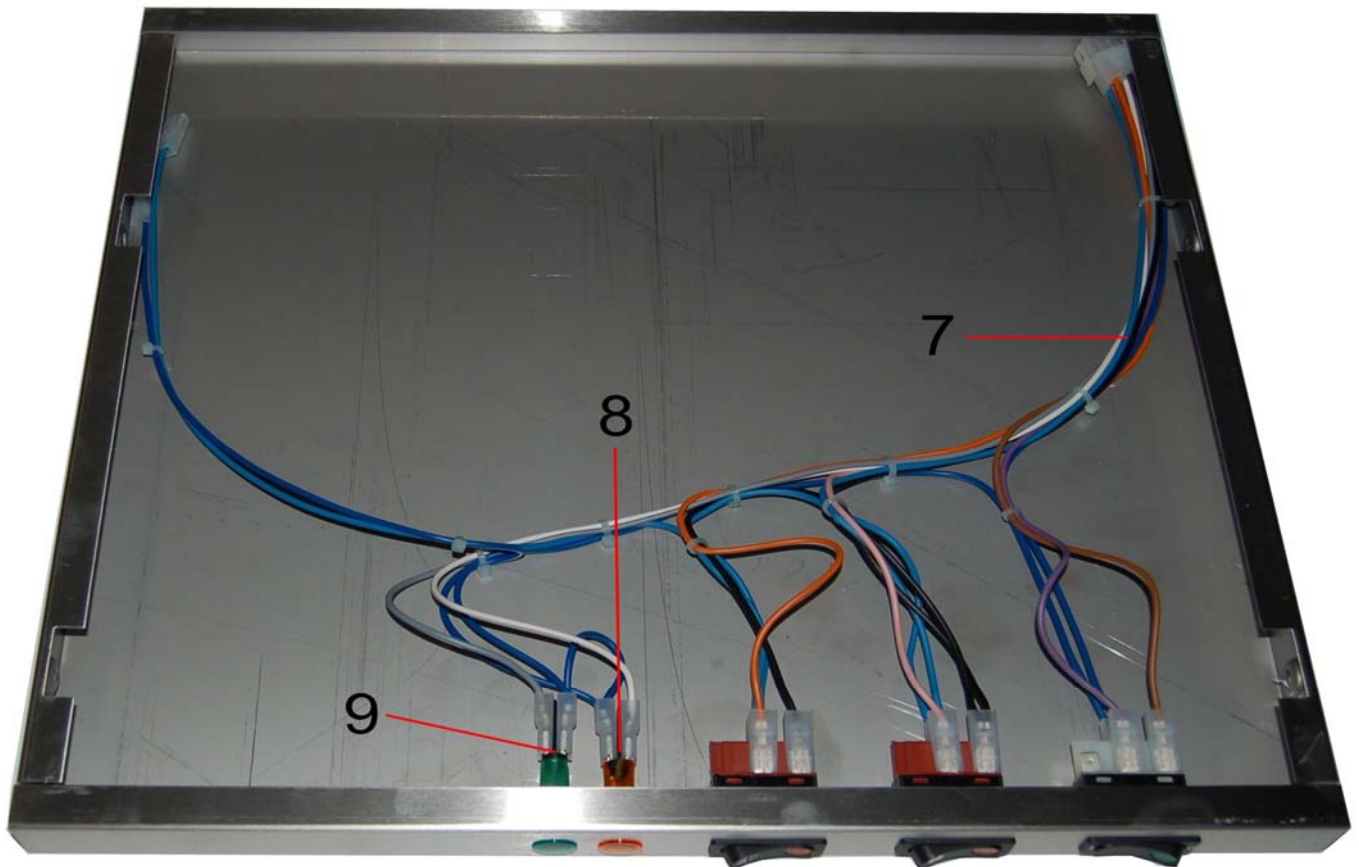
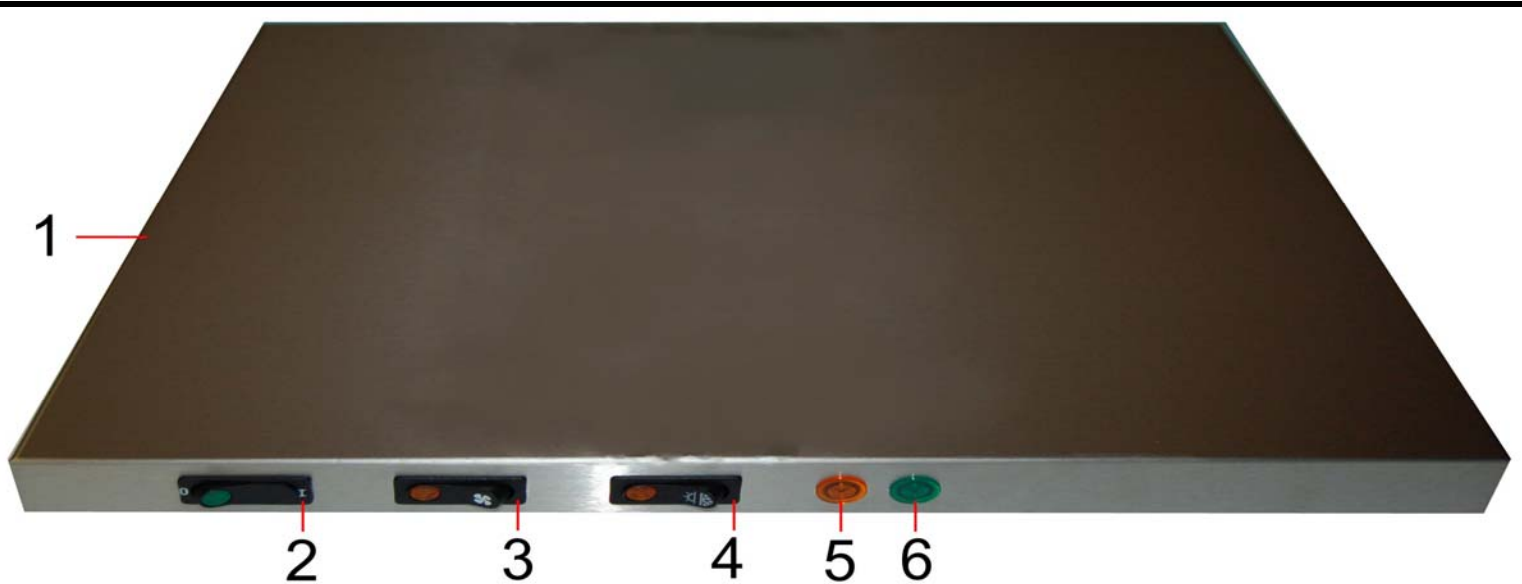

Pos.	Codice	Descrizione	Description	Description
1	GMPS1CSN	Pannello superiore inox	Top panel, steel	Panneau supérieur
2	CEIN3012	Interruttore 0-1	ON-OFF switch	Interrupteur ON-OFF
3	CEPUC3012	Pulsante ciclo	Cycle start switch	Bouton start cycle
4	CEPUR3012	Pulsante risciacquo freddo	Rinse push button	Bouton rinçage froid
5	CESPE32	Gemma arancio	Cover, orange	Voyant orange
6	CESPE31	Gemma verde	Cover, green	Voyant vert
7	CECBSPCCS	Cablaggio superiore	Upper loom	Cable supérieur
8	CESP27	Spia arancio	Warning light, orange	Ampoule voyant, orange
9	CESP27V	Spia verde	Warning light, green	Ampoule voyant, verte

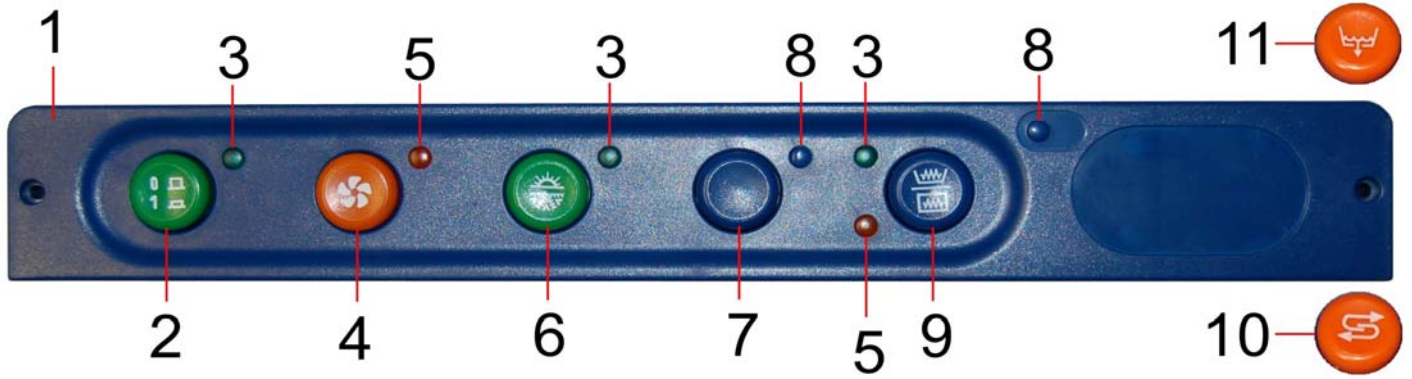

Pos.	Codice	Descrizione	Description	Description
1	CEPC1D25	Pannello comandi blu	Control panel, plastic, blue	Panneau de commande
2	CETP25V01	Tasto tondo verde "0-1"	On/off button, round, green	Bouton "0-1", rond, vert
3	CEGV6	Gemma verde, 6mm	Lens, green, 6mm	Voyant vert, 6mm
4	CETP25APC	Tasto tondo arancio "partenza ciclo"	Cycle start button, round, orange	Bouton "Depart cycle", rond, orange
5	CEGA6	Gemma arancio dm. 6mm	Lens, orange, 6mm	Voyant orange, 6mm
6	CETP25VRF	Tasto tondo verde "risciacquo freddo"	Cold rinse button, round, green	Bouton "Rinçage froid", rond, vert
7	CETP25B	Tasto tondo blu "tappo"	Button, round, blue	Bouton "Bouchon", rond, bleu
8	CETP6B	Tappo foro spia blu, 6mm	Cap, warning light, blue, 6mm	Bouchon bleu, 6mm
9	CETP25BR	Tasto tondo blu "resistenze"	Heater indicator button, round, blue	Bouton "Résistance", rond, bleu
10	CETP25AR	Tasto tondo arancio "rigenerazione"	Re-set button, round, orange	Bouton "Régénération", rond, orange
11	CETP25APS	Tasto tondo arancio "pompa scarico"	Drain button, round, orange	Bouton "Pompe de vidange", orange

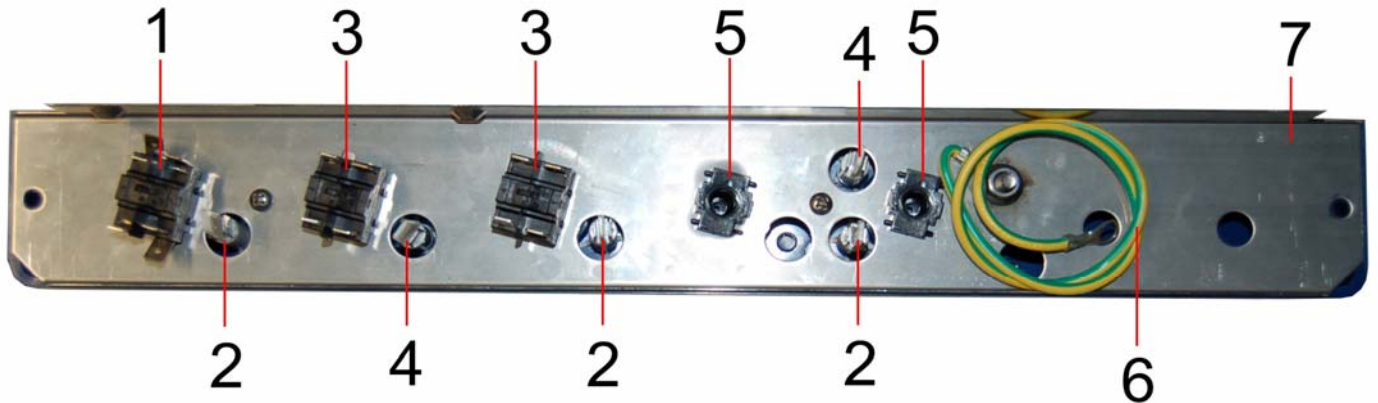

Pos.	Codice	Descrizione	Description	Description
1	CEDPPFD	Deviatore bipolare	Inner switch, latched	Deviateur bipolaire
2	CESPV6	Lampada verde, 6mm	Lamp assy, 6mm, green	Ampoule vert, 6mm
3	CEPBPF	Pulsante bipolare	Inner push button momentary	Bouton bipolaire
4	CESPA6	Lampada arancio, 6mm	Lamp assy, 6mm, orange	Ampoule orange, 6mm
5	CETP25SF	Supporto tasto fisso	Support for indicator button	Support bouton fixe
6	CECBCTB2	Catenaria circuito terra	Earth grounding wire	Cable de circuit à la terre
7	GMPI1NOS	Portainterruttori inox	Steel control panel	Porte-interrupteur inox

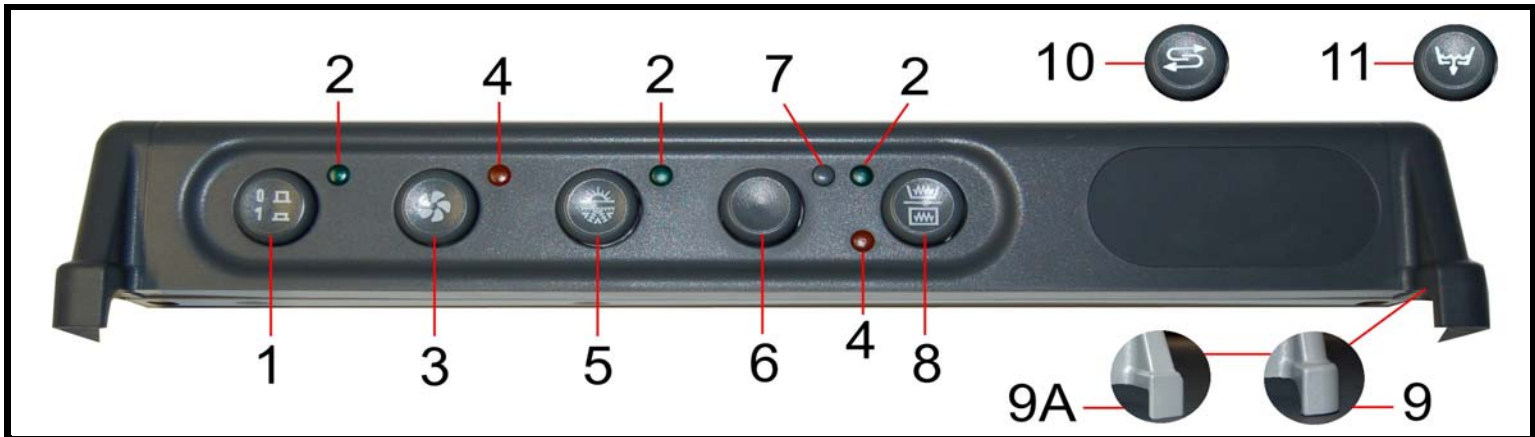

Pos.	Codice	Descrizione	Description	Description
1	CETP25G01	Tasto tondo grigio "0-1"	On/off button, round, grey	Bouton "0-1", rond gris
2	CEGV6	Gemma verde 6mm	Lens, green, 6mm	Voyant vert, 6mm
3	CETP25GPC	Tasto tondo grigio "partenza ciclo"	Cycle start button, round, grey	Bouton "Départ cycle", rond, gris
4	CEGA6	Gemma arancio 6mm	Lens, orange, 6mm	Voyant orange, 6mm
5	CETP25GRF	Tasto tondo grigio "risciacquo freddo"	Cold rinse button, round, grey	Bouton "Rinçage froid", rond, gris
6	CETP25GR	Tasto tondo grigio "tappo"	Button, round, grey	Bouton "Bouchon", rond, gris
7	CETP6GR	Tappo spia grigio 6mm	Cap, warning light, grey	Bouchon gris, 6mm
8	CETP25GRRS	Tasto tondo grigio "resistenze"	Heater indicator button, round, grey	Bouton "Résistances", rond, gris
9	CEPC1D25RGR	Pannello comandi vasca raggiata	Control panel, plastic, grey	Panneau de contrôle, plastique, gris
9A	CEPC1D25QGR	Pannello comandi vasca quadra	Control panel, plastic, grey	Panneau de contrôle, plastique, gris
10	CETP25GRR	Tasto tondo grigio "rigenerazione"	Regeneration button, round, grey	Bouton "Régénération", rond, gris
11	CETP25GPS	Tasto tondo grigio "pompa scarico"	Drain pump button, round, grey	Bouton "Pompe de vidange", rond, gris

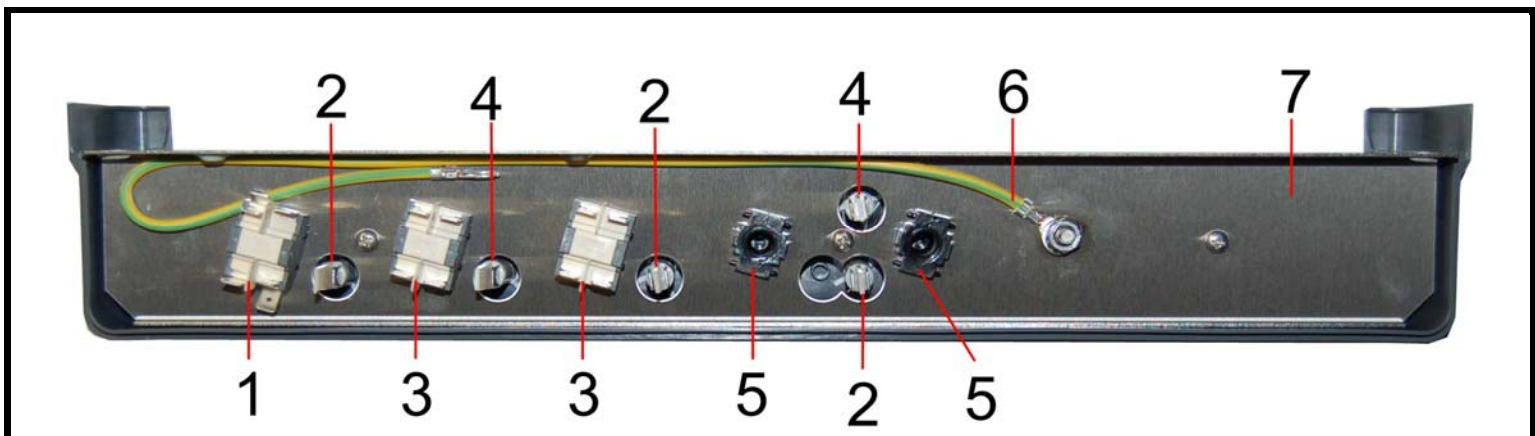

Pos.	Codice	Descrizione	Description	Designation
1	CEDPPFD	Deviatore bipolare	Inner switch, latched	Deviateur bipolaire
2	CESPV6	Lampada verde 6mm	Lamp assy, 6mm, green	Ampoule verte, 6mm
3	CEPBPF	Pulsante bipolare	Inner push button momentary	Bouton bipolaire
4	CESPA6	Lampada arancio 6mm	Lamp assy, 6mm, orange	Ampoule orange, 6mm
5	CETP25SF	Supporto tasto fisso	Support for indicator button	Support bouton fixe
6	CECBCTB2	Catenaria circuito terra	Earth grounding wire	Cable de circuit à la terre
7	GMPI1D25RDP	Portainterruttori inox	Steel inner control panel	Porte-interrupteur inox

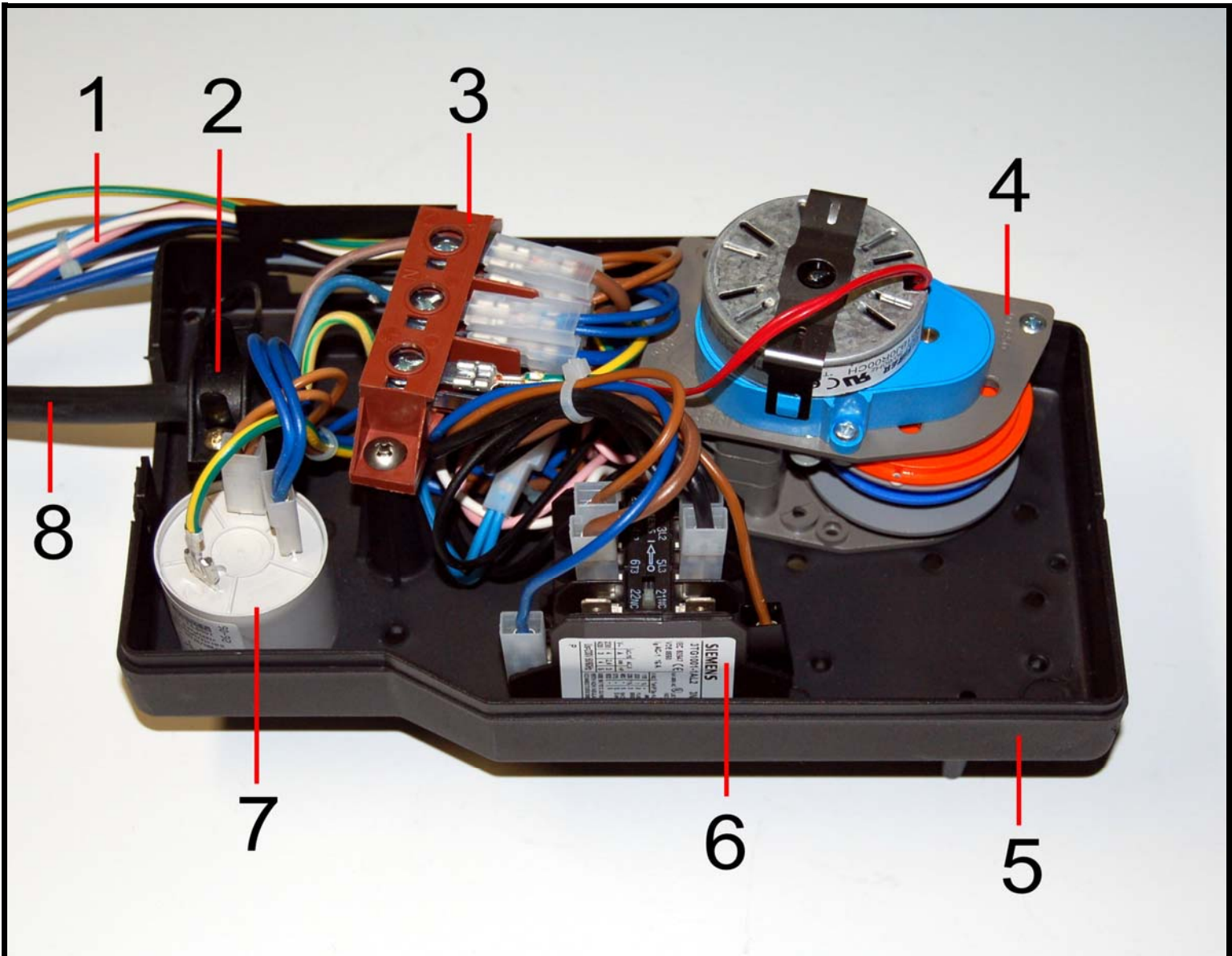

Pos.	Codice	Descrizione	Description	Description
1	CECBJ	Cablaggio	Lower loom	Cable de connexion
2	CEFI6	Fissacavo interno con viti	Cable clamp	Arrêt de câble intérieur
3	CEM0S	Morsettiera	3-way terminal block	Bornier
4	CETF150J05	Timer ciclo	Cycle timer, 2.1/2 mins, type B	Timer cycle
5	CEPCEBCSL	Base scatola cablaggio	Electric component box body	Boite cablage
6	CECTF	Teleruttore	4-p contactor	Contacteur
7	CEFA	Filtro antidisturbo	Suppressor	Filtre électrique
8	CECE25J	Cavo alimentazione	Electric supply cable	Cable d'alimentation
9	CEPCECCSL	Coperchio scatola cablaggio	Electric component box lid	Couvercle boite cablage
10	CECBJCC	Scatola cablaggio completa assemblata	Electrical component assembly	Boite cablage

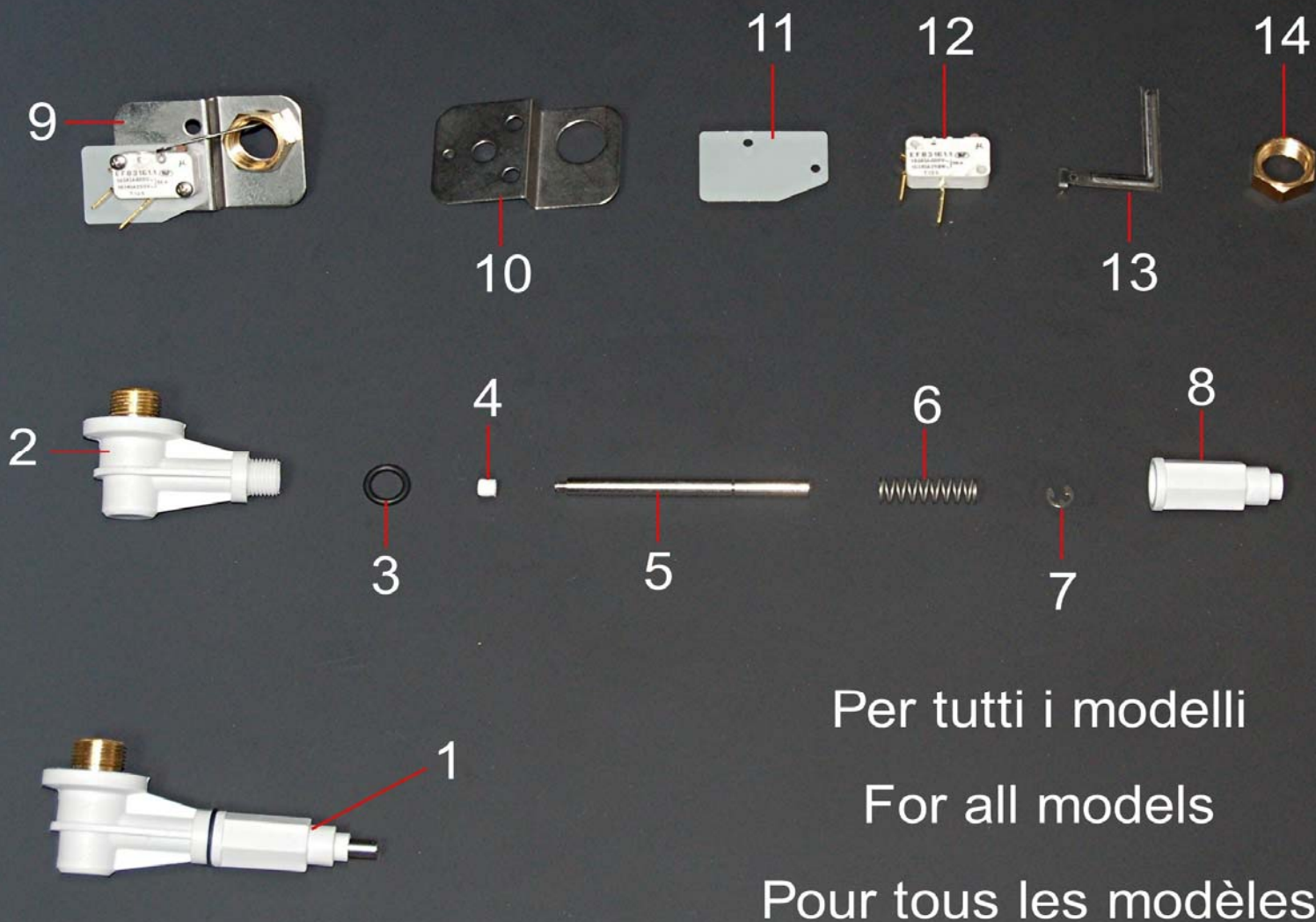

Pos.	Codice	Descrizione	Description	Description
1	CEMP1823B	Sicurezza porta completa	Door plunger assembly	Securité de porte assemblé
2	CEMP18B	Corpo posteriore sicurezza porta	Door plunger elbow	Corps postérieur
3	OR4036	Or sicurezza porta	O ring 4036	Joint OR 4036
4	CEMPPIB	Puntale isolante astina sicurezza porta	Push rod end cap	Poussoir plastique
5	CEMP21	Astina sicurezza porta	Push rod	Tige sécurité porte
6	CEMP20	Molla sicurezza porta	Door plunger spring	Ressort sécurité porte
7	CEMP22	Seeger astina sicurezza porta	Circlip	Circlips
8	CEMP23B	Corpo anteriore sicurezza porta	Door plunger body	Corps antérieur
9	CEMP12CSC	Microinterruttore standard completo	Door switch assy complete	Micro contact porte complet
10	CEMP13CS	Squadretta micro porta standard	Bracket for door switch	Support interrupteur
11	CEISOMPNT	Isolante micro porta	Insulating plate	Isolant
12	CEMP12SM	Microinterruttore	Door micro switch only	Interrupteur
13	CEMP12ACS	Leva microinterruttore standard	Operating arm, right angled	Levier micro-interrupteur
14	D038A	Dado ottone 3/8"	Brass lock nut 3/8"	Ecrou 3/8"

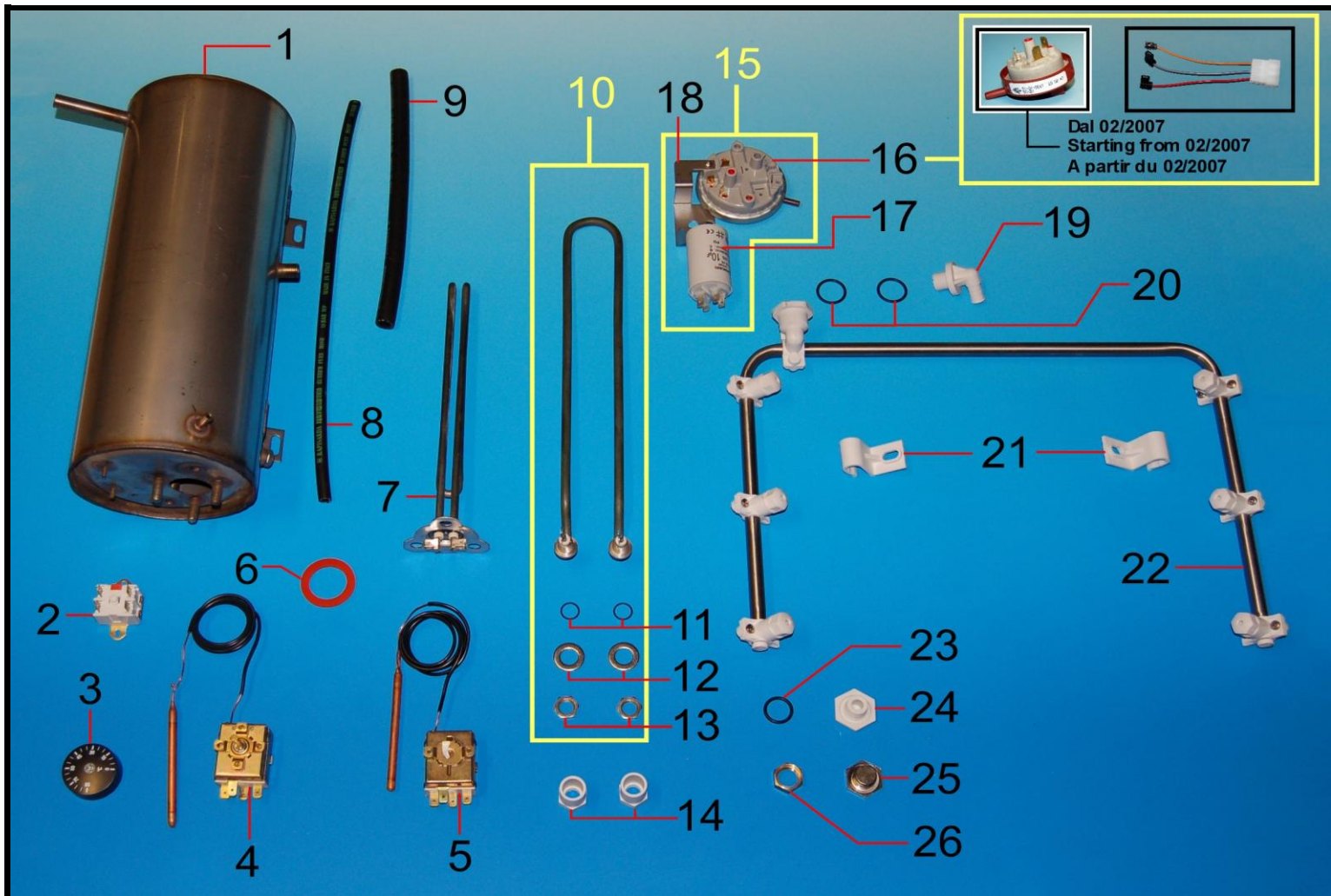

Pos.	Codice	Descrizione	Description	Description
1	GB11NT	Boiler	Boiler	Surcailleur
2	CESB454	Termostato sicurezza boiler	Boiler safety thermal switch	Termostat sécurité surcailleur
3	CEMTB	Manopola termostato	Knob, thermostat	Manette thermostat
4	CETB85	Termostato boiler regolabile	Adjustable control thermostat	Termostat surcailleur réglable
5	CETV55	Termostato vasca fisso	Fixed wash control thermostat	Termostat cuve fix
6	G42303S	Guarnizione resistenza boiler	Rinse element seal, small	Joint torique résistance surcailleur
7	CERB22	Resistenza boiler 2200 W	Rinse element, 2.2kW	Résistance surcailleur 2200 W
8	TG510DS	Tubo gomma 5x10	R-aid tube to boiler	Tuyau caoutchouc 5x10
9	TG1117	Tubo gomma 11x17	Standard rinse hose 11mm bore	Tuyau caoutchouc 11x17
10	CERV8	Resistenza vasca 800 w	Wash element, 0.8kW	Résistance de cuve 0,8 Kw
11	ORRV	Or resistenza vasca	O rings for wash element	Joint torique résistance cuve
12	VRP12I	Rondella piana Ø 12	Washer	Rondelle, diam 12mm
13	VDRV	Dado resistenza vasca	Lock nut	Ecrou fixation résistance cuve
14	CEPRV0	Protezione resistenza vasca	Protection, wash element	Protection résistance cuve
15	AM0SQPCS1C	Squadretta assemblata condensatore pressostato	Assembly, pressure switch and capacitor	Support résistance condensateur
16	CEPR	Pressostato	Air pressure switch	Pressostat
17	CECN10	Condensatore	Capacitor 10 mi-F	Condensateur
18	AM0SQPCS	Squadretta inox	Bracket	Support inox
19	GRS06B	Raccordo fissaggio asta esterno	Inlet elbow	Raccord fixation rampe de rinçage
20	OR128	Or 128	O ring 128	Joint support
21	GRS05B	Gancio fissaggio asta	Securing clamp	Crochet de support rampe
22	GRS1QBCM	Asta risciacquo assemblata	Fixed rinse arm complete	Rampe de rinçage supérieure complète
23	OR122	Or 122	O ring 122	Joint torique
24	D0T38PB	Tappo 3/8 ppl	Tank plug, plastic	Bouchon
25	D0T38	Tappo 3/8 ottone	Tank plug	Bouchon, laiton
26	D038A	Dado 3/8	3/8" brass nut	Ecrou fixation support rinçage 3/8"

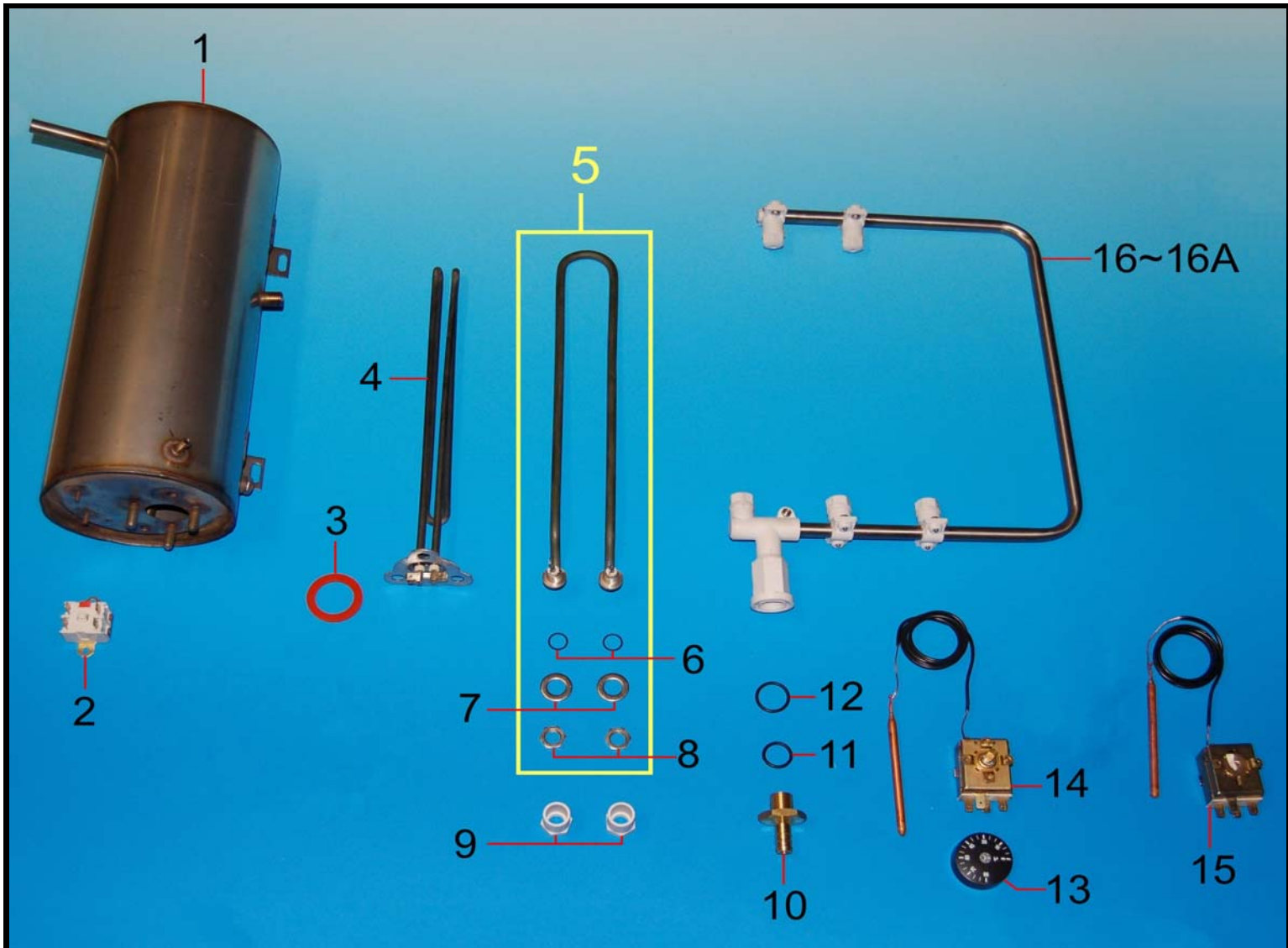

Pos.	Codice	Descrizione	Description	Description
1	GB11NT	Boiler	Boiler	Surchauffeur
2	CESB454	Termostato sicurezza boiler	Rinse safety thermal switch	Termostat sécurité surchauffeur
3	G42303S	Guarnizione resistenza boiler	Rinse element seal, small	Joint torique résistance surchauffeur
4	CERB22	Resistenza boiler 2200 w	Rinse element, 2.2kW	Résistance surchauffeur, 2.2kW
5	CERV8	Resistenza vasca 800 w	Wash element, 0.8kW	Résistance de cuve, 0.8kW
6	ORRV	Or resistenza vasca	O rings for wash element	Joint torique résistance cuve
7	VRP12I	Rondella piana, diam 12mm	Washer, D. 12	Rondelle, diam. 12mm
8	VDRV	Dado resistenza vasca	Lock nut	Ecrou fixation résistance cuve
9	CEPRVV0	Protezione resistenza vasca	Protection, wash element	Protection résistance cuve
10	GR016PNT	Supporto asta con portagomma	Rinse arm lower support	Support rampe rinçage
11	OR122	Or 122	O ring 122	Joint torique
12	OR128	Or 128	O ring 128	Joint support
13	CEMTB	Manopola termostato	Knob, thermostat	Manette thermostat
14	CETB85	Termostato boiler regolabile	Adjustable control thermostat	Thermostat surchauffeur réglable
15	CETV55	Termostato vasca fisso	Fixed wash control thermostat	Thermostat cuve fixe
16	GR119INB	Asta risciacquo assemblata mod. 1	Steel rinse tube assembly	Rampe rinçage complète
16A	GR1A19INB	Asta risciacquo assemblata mod. 1 alta	Steel rinse tube assembly, mod. 1, tall	Rampe rinçage complète, porte haute

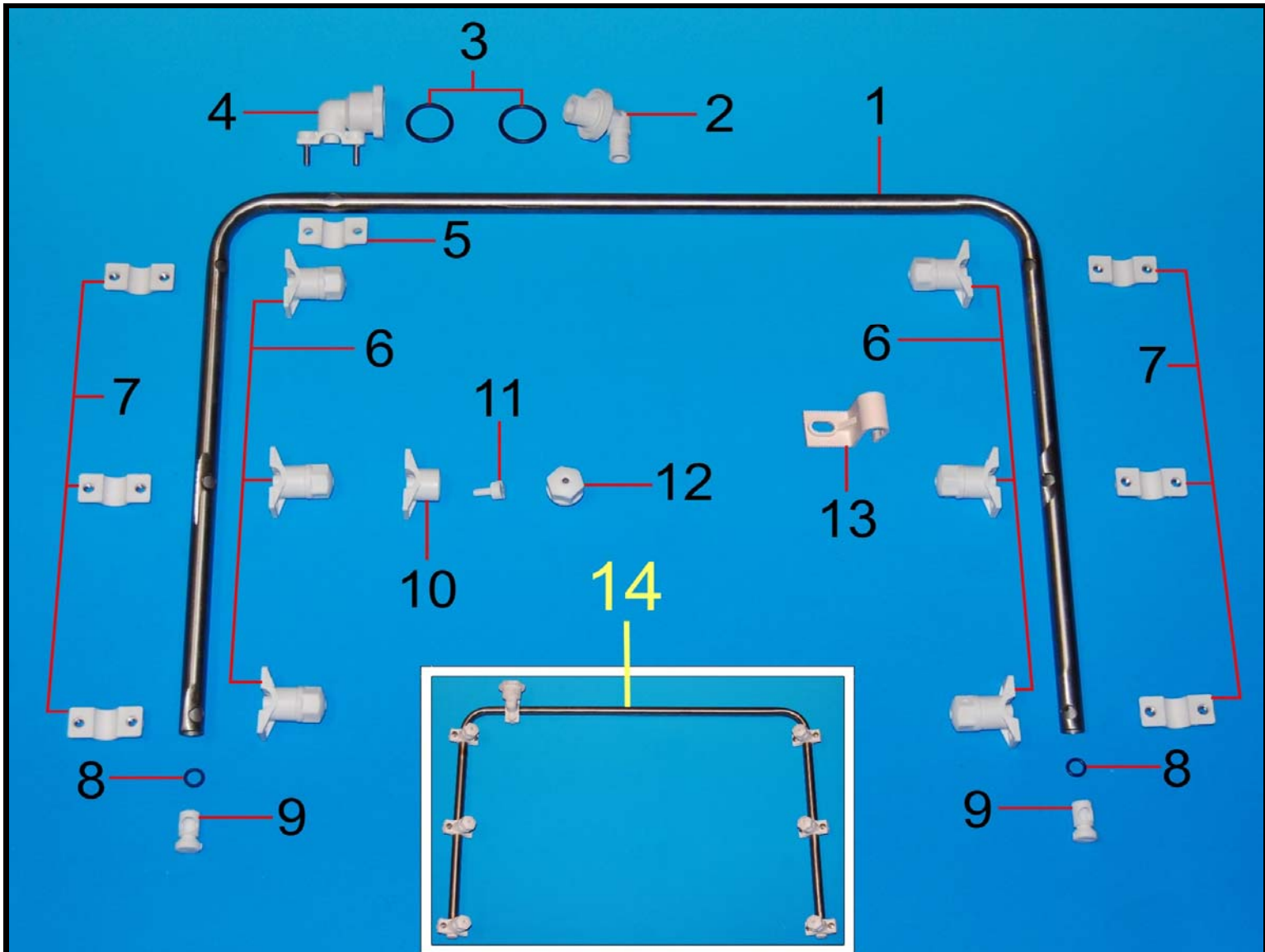

Pos.	Codice	Descrizione	Description	Description
1	GRS1Q	Asta inox	Steel tube for top rinse	Rampe inox
2	GRS06B	Raccordo fissaggio asta esterno	Inlet elbow	Raccord tenue rampe de rinçage extérieur
3	OR128	Or 128	O ring 128	Joint support
4	GRS03B	Raccordo asta interno	Rinse connection clamp	Raccord tenue rampe de rinçage intérieur
5	GRS04B	Cavalotto fissaggio asta	Rinse tube clamp	Support supérieur fixage rampe
6	GR019BBCOMP	Portagetto risciacquo assemblato	Rinse jet clamp assy	Support gicleur
7	GR019DB	Supporto inferiore portagetto	Rinse jet rear clamp	Support inférieur gicleur
8	OR106	Or 106	O ring 106	Joint torique pour poignée
9	GR019GB	Tappo asta	Rinse arm plug	Bouchon rampe inox
10	GR019BB	Portagetto risciacquo	Rinse jet base	Support supérieur gicleur rinçage
11	GR021B	Diffusore risciacquo	Rinse jet spinner	Diffuseur de rinçage
12	GR020B	Getto risciacquo	Rinse jet	Gicleur de rinçage
13	GRS05B	Gancio fissaggio asta	Securing clamp	Crochet de support rampe
14	GRS1QBCM	Asta risciacquo assemblata	Fixed rinse arm complete	Rampe de rinçage supérieure complète

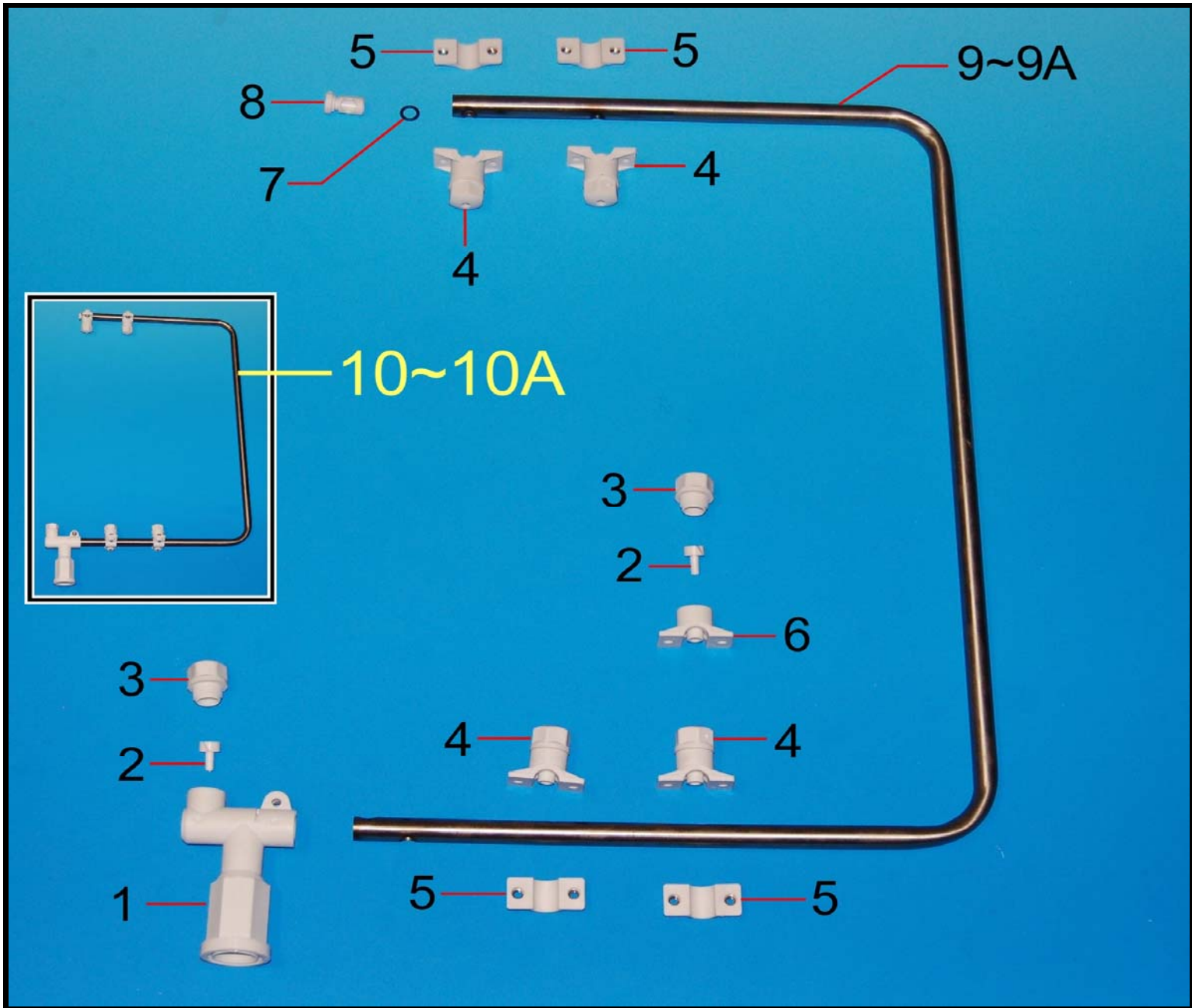

Pos.	Codice	Descrizione	Description	Description
1	GR019ANTB	Supporto asta	Rinse arm upper support	Support rampe
2	GR021B	Diffusore risciacquo	Rinse jet spinner	Diffuseur de rinçage
3	GR020B	Getto risciacquo	Rinse jet	Gicleur rinçage
4	GR019BBCOMP	Portagetto risciacquo assemblato	Rinse jet clamp assy	Support sup. gicleur rinçage complet
5	GR019DB	Supporto inferiore portagetto	Rinse jet rear clamp	Support inférieur gicleur
6	GR019BB	Portagetto risciacquo	Rinse jet base	Support supérieur gicleur rinçage
7	OR106	Or 106	O ring 106	Joint torique pour poignée
8	GR019GB	Tappo asta	Rinse arm plug	Bouchon rampe inox
9	GR119C	Asta inox mod. 1	Steel rinse tube	Rampe inox rinçage, porte haute
9A	GR1A19C	Asta inox mod. 1 alta	Steel rinse tube, tall model	Rampe inox rinçage, mod. 1 haut
10	GR119INB	Asta risciacquo assemblata mod. 1	Steel rinse tube assembly, mod.1	Rampe rinçage complet, mod.1
10A	GR1A19INB	Asta risciacquo assemblata mod. 1 alta	Steel rinse tube assembly, tall model	Rampe rinçage complet, porte haute

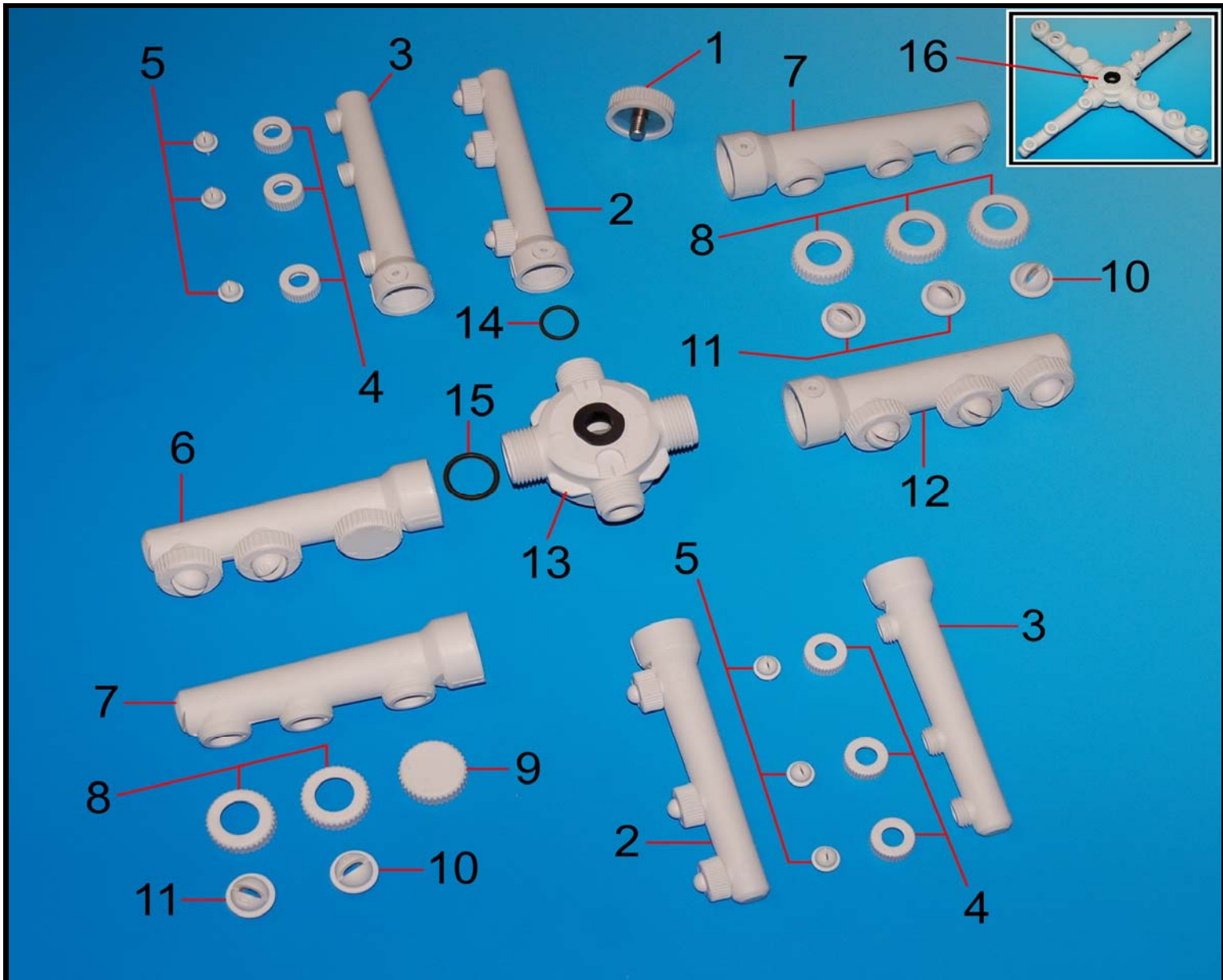

Pos.	Codice	Descrizione	Description	Description
1	LS09PB	Nottolino fissaggio girante	Spindle retaining nut	Ecrou pour pivot
2	LSI16CDSB	Asta risciacquo sinistra/destra assemblata	LH rinse arm complete	Rampe rinçage gauche/droite complèt
3	LSI16CB	Asta risciacquo	Rinse arm only	Rampe rinçage
4	LSI021B	Ghiera fissaggio getto risciacquo	Locating nut for rinse jets	Ecrou fixation gicleur rinçage
5	LSI020B	Getto risciacquo	Rinse jet	Gicleur rinçage
6	LSI16BSB	Asta lavaggio sinistra assemblata	LH wash arm, complete	Rampe lavage gauche avec gicleurs
7	LSI16BB	Asta lavaggio	Wash arm only	Rampe lavage
8	LSI017B	Ghiera fissaggio getto lavaggio	Locating nut for wash jets	Ecrou serrage gicleur lavage
9	LSI018B	Tappo getto lavaggio	Wash arm blank	Bouchon gicleur de lavage
10	LSI016B	Getto lavaggio sinistro stretto	Wash jet, LH, marked "s"	Gicleur lavage gauche
11	LSI015B	Getto lavaggio destro stretto	Wash jet, RH marked "d"	Gicleur lavage droite
12	LSI16BDB	Asta lavaggio destra assemblata	RH wash arm complete	Rampe lavage droite avec gicleurs
13	LSI0607AB	Mozzo girante	Centre boss c/w bushes	Moyeu central avec bagues
14	OR118	Or 118	O ring 118	Joint torique rampe rinçage
15	OR124	Or 124	O ring 124	Joint torique rampe lavage
16	LSI16BBB	Girante completa assemblata	Rotating wash assy complete	Tourniquet complet

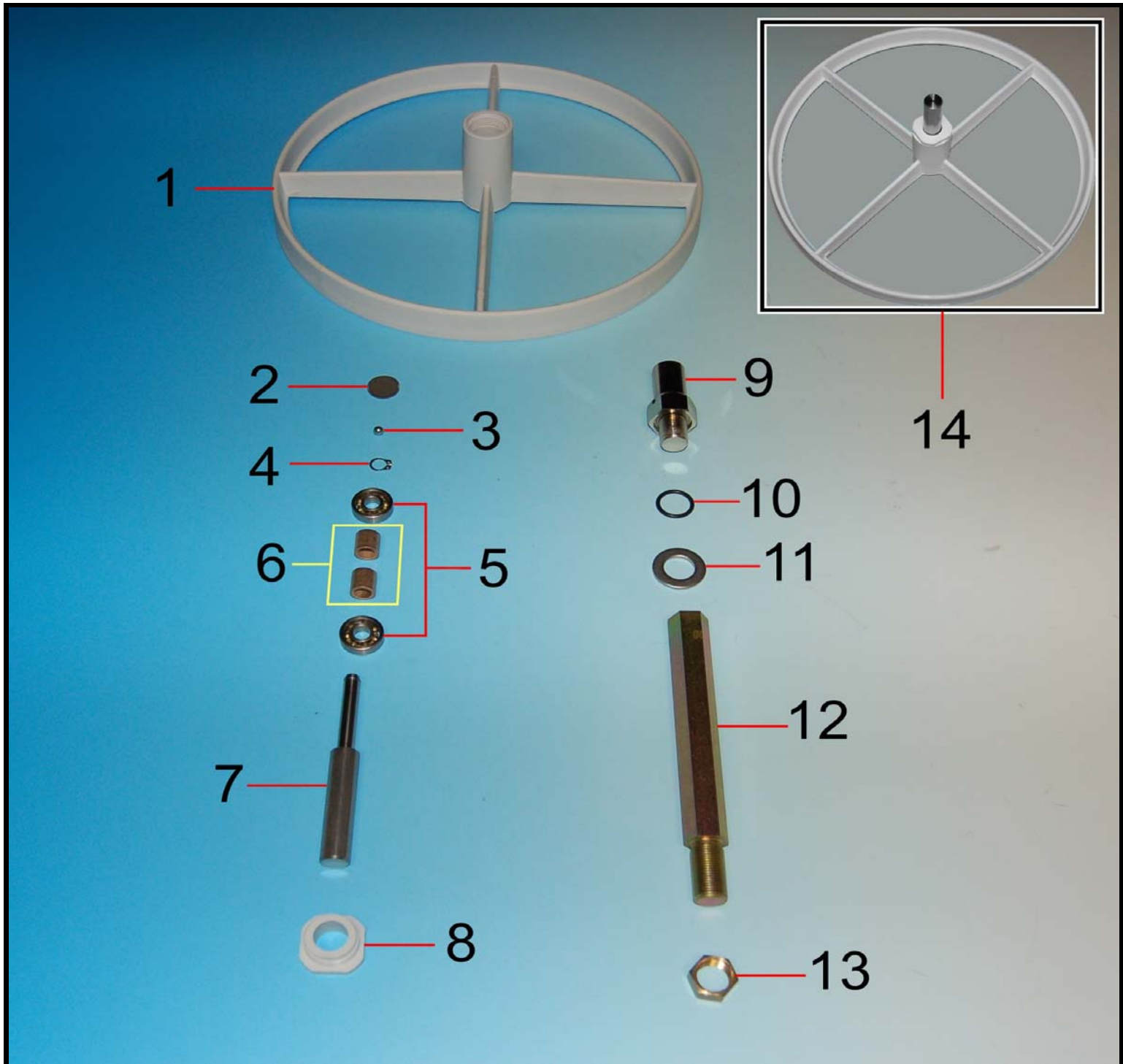

Pos.	Codice	Descrizione	Description	Description
1	GG1TAB	Girello parte ppl	Turntable	Tourniquet
2	GG1TB	Dischetto inox	Steel bearing ring	Petit disque inox
3	GG1T1E	Sfera girello piccolo	Seal	Joint
4	GG1TE	Seeger	Circlip for turntable	Circlip
5	GG1TC	Cuscinetto per girello girante	Ball bearing for turntable	Roulement inox
6	GG1TD	Distanziale albero girello	Spacer for turntable	Entretoise
7	GG1TFEG	Perno girello con sfera	Stud turntable with ball	Tourillon tourniquet avec bille
8	GG1THB	Ghiera fissaggio perno girello	Ring nut for turntable	Ecrou plastique
9	GG1T2	Supporto girello	Support for turntable	Support tourniquet
10	OR122	Or 122	O-ring 122	Joint
11	GG0T4	Rondella piana Ø 16	Flat washer, diam 16 mm	Rondelle, diam 16 mm
12	GG1T5	Tirante esagonale	Hexagonal spacer column	Tirant hexagonal
13	DO38A	Dado 3/8	Brass lock nut 3/8"	Ecrou tenue support rinçage
14	GG1T1	Girello completo assemblato	Turntable assembly	Volant complet

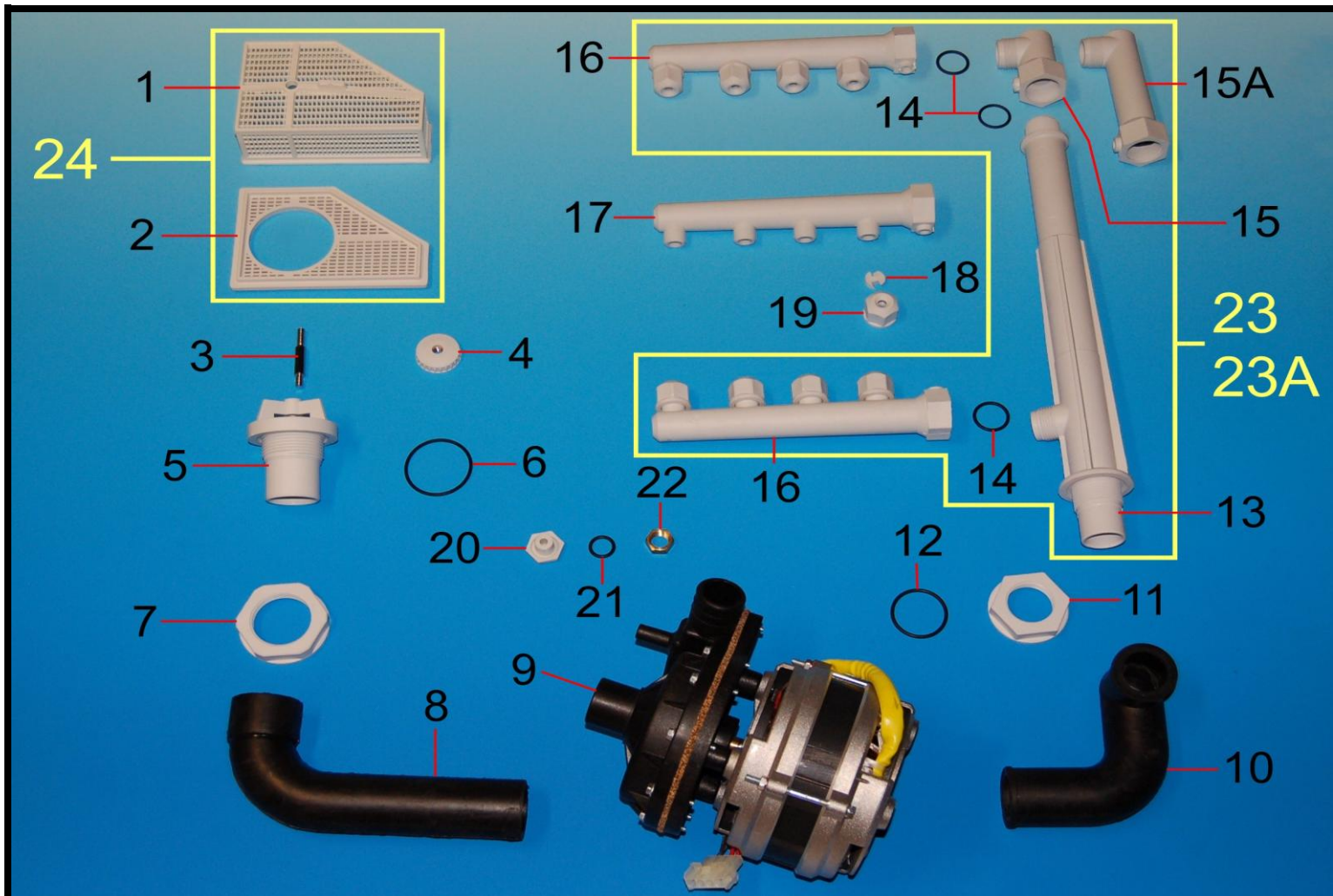

Pos.	Codice	Descrizione	Description	Description
1	GA115RV0	Filtro aspirazione	Plastic filter upper body	Filtre d'aspiration
2	GA115RAV0	Piastra filtro aspirazione	Plastic filter base	Plaqué inférieure filtre
3	GAGS1299	Astina filtro	Filter spindle	Tige de filtre
4	GA013B	Nottolino filtro	Filter retaining nut	Ecrou de filtre
5	GA111B	Piletta aspirazione	Drain filter boss	Bonde d'aspiration
6	OR3168	Or 3168	O-ring 3168	Joint 3168
7	DP114	Dado 1" ¼	Plastic nut	Ecrou plastique , 1"1/4
8	GA18	Manicotto aspirazione	Inlet hose	Durite d'aspiration
9	EP30	Elettropompa	Wash pump complete, 0.3 HP	Pompe de lavage, complète
10	GL1T22	Manicotto mandata	Outlet hose	Durite de réfolement
11	DP1	Dado 1"	Nut 1"	Ecrou plastique , 1"
12	OR3131	Or 3131	O-ring 3131	Joint torique pour colonne
13	GL1T27B	Colonna lavaggio	Wash column	Colonne de lavage
14	OR128	Or 128	O-ring 128	Joint support
15	GL1T32B	Prolunga colonna mod.1	Wash column spacer, mod.1	Extension colonne de lavage, mod.1
15A	GL2T32B	Prolunga colonna mod.1 alta	Wash column spacer, mod. 1 high	Extension colonne lavage, mod. 1 haute
16	GL1T28BCM	Asta lavaggio completa	Wash arm assembly	Rampe de lavage complète
17	GL1T28PB	Asta lavaggio	Wash arm	Rampe de lavage
18	GL031B	Diffusore getto lavaggio	Wash jet spinner	Diffuseur de lavage
19	GL030B	Getto lavaggio	Wash jet	Gicleur de lavage
20	D0T14PB	Tappo ¼ ppl	Tank plug 1/4"	Bouchon 1/4"
21	OR117	Or 117	O-ring 117	Joint torique pour bouchon
22	D014	Dado ¼"	Brass nut 1/4"	Ecrou 1/4"
23	GL1T27BC	Colonna lavaggio mod.1 completa	Wash column assembly, mod. 1	Colonne de lavage, mod.1, complète
23A	GL1AT27BC	Colonna lavaggio mod.1 alta completa	Wash column assembly, mod. 1 high	Colonne lavage, mod.1 haute, complète
24	GA115RCBV0	Filtro aspirazione completo	Plastic filter, complete	Filtre d'aspiration complet

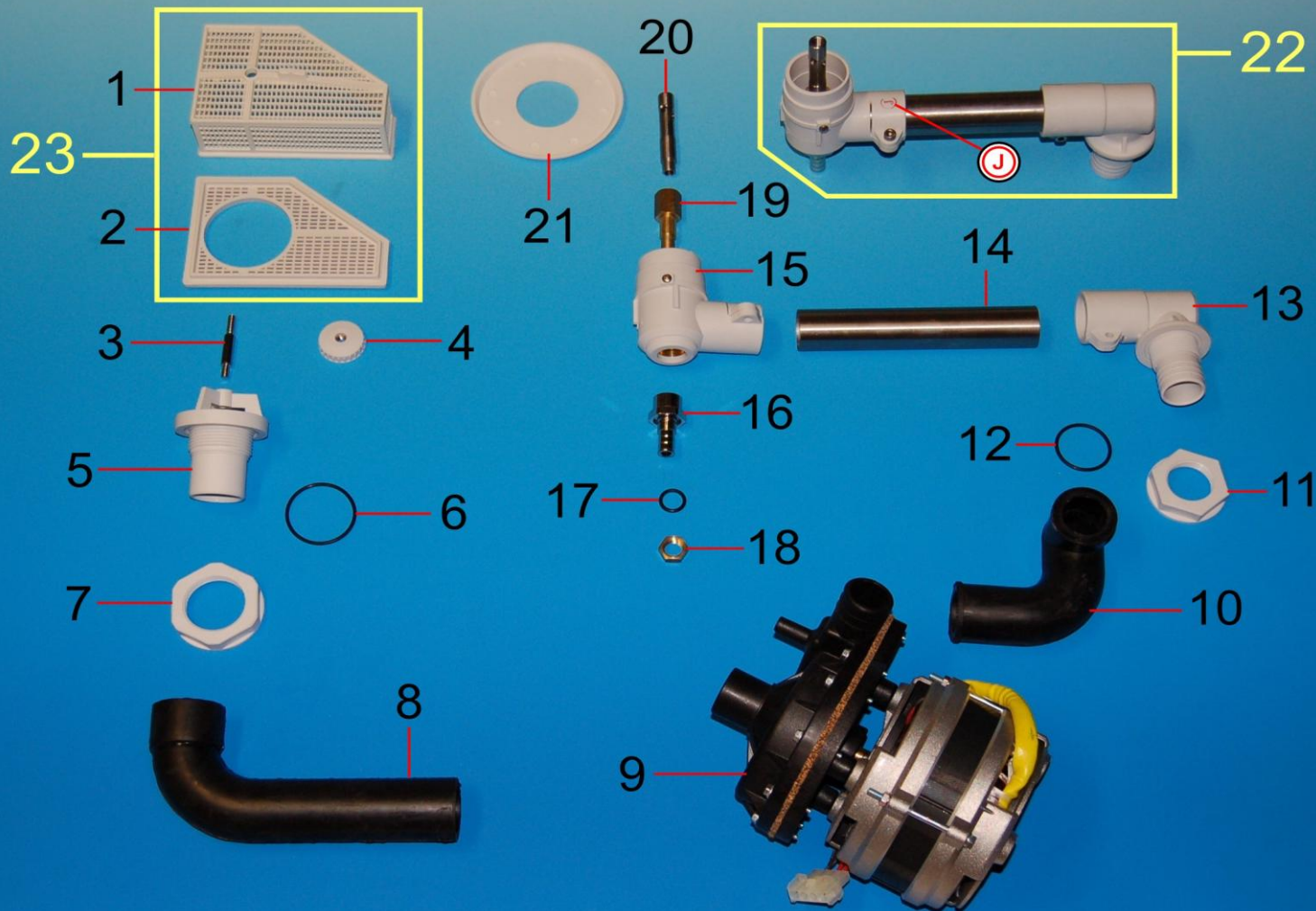

Pos.	Codice	Descrizione	Description	Description
1	GA115RV0	Filtro aspirazione	Plastic filter upper body	Filtere d'aspirazione
2	GA115RAV0	Piastra filtro aspirazione	Plastic filter base	Plaquette inférieure filtre
3	GAGS1299	Astina filtro	Filter spindle	Tige de filtre
4	GA013B	Nottolino filtro	Filter retaining nut	Ecrou de filtre
5	GA111B	Piletta aspirazione	Drain filter boss	Bonde d'aspiration
6	OR3168	Or 3168	O-ring 3168	Joint 3168
7	DP114	Dado 1" ¼	Plastic nut 1"1/4	Ecrou plastique 1"1/4
8	GA18	Manicotto aspirazione	Inlet hose	Durite d'aspiration
9	EP30	Elettropompa	Wash pump complete, 0.3 HP	Pompe de lavage, 0,3 HP
10	GL1T22	Manicotto mandata	Outlet hose	Durite de refoulement
11	DP1	Dado 1"	Nut 1"	Ecrou plastique , 1"
12	OR3131	Or 3131	O-ring 3131	Joint torique pour colonne
13	LI126FCB	Piletta entrata lavaggio	Wash elbow and column	Bonde entrée complète
14	LI12830	Tubo inox interno	Wash extension tube	Tube inox
15	LI029CBB	Supporto inferiore	Bottom boss assy	Support inférieur complet
16	LI133FOT	Supporto risciacquo	Rinse support	Support rinçage
17	OR117	Or 117	O-ring 117	Joint torique pour bouchon
18	D014	Dado ¼"	Brass nut 1/4"	Ecrou 1/4"
19	LI130	Prolunga perno	Spindle extension	Extension pivot
20	LI18F	Perno inox	Stainless steel upper spindle	Pivot inox rinçage
21	LI034PV0	Piattello inferiore	Deflector disk	Défecteur
22	GLICQ1JBCOMP	Gruppo inferiore completo assemblato	Lower elbow and boss assy complete	Groupe inférieur complet
23	GA115RCBV0	Filtro aspirazione completo	Plastic filter, complete	Filtere d'aspiration complet

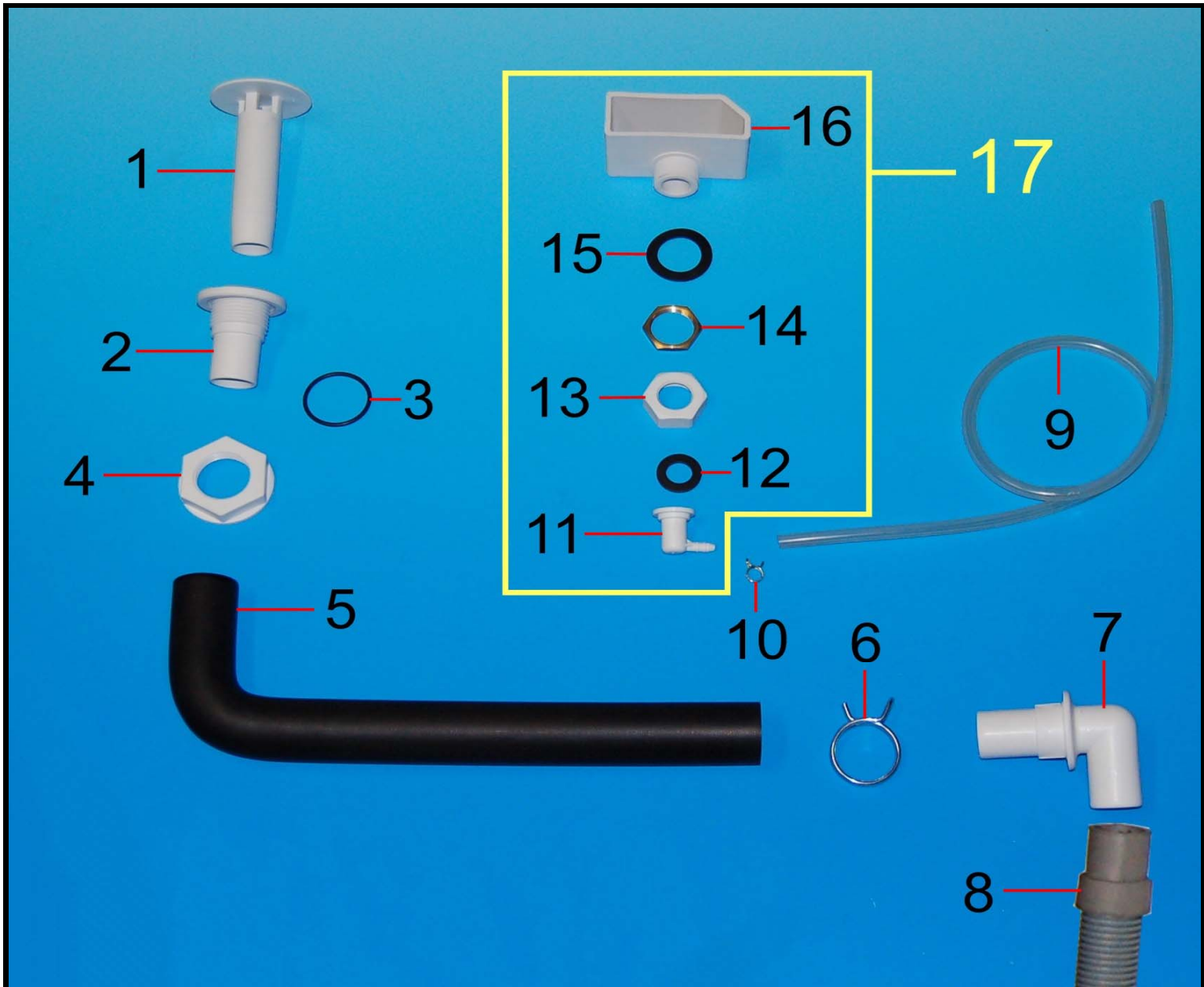

Pos.	Codice	Descrizione	Description	Description
1	GS116CCAB	Troppo pieno	Drain plug or standpipe	Bonde trop-plein, complète
2	GS117B	Piletta di scarico	Drain outlet boss	Bonde de vidange
3	OR3131	Or 3131	O-ring 3131	Joint torique pour colonne
4	DP1	Dado 1"	Nut 1"	Ecrou plastique
5	GS120	Manicotto di scarico mod.1	Drain hose, mod. 1	Durite de vidange, mod. 1
6	FAM3040	Fascetta a molla	Hose clip 30-40	Collier élastique
7	GS121	Raccordo scarico 90°	Drain elbow 90°	Raccord de vidange à 90°
8	GS130	Tubo di scarico	Drain hose	Tuyau de vidange
9	TSIL48	Tubo silicone	Rinse-aid tube	Tuyau
10	FAM58	Fascetta a molla	Spring clip	Collier
11	GP026AB	Raccordo girevole	Air trap elbow	Raccord tournant
12	G251525G	Guarnizione raccordo girevole	Sealing washer	Joint raccord tournant
13	GP026BB	Dado raccordo girevole	Air tap elbow nut	Ecrou pour raccord tournant
14	D034	Dado ¾"	Brass nut, 3/4"	Ecrou 3/4"
15	G382615G	Guarnizione trappola aria	Air trap seal	Joint
16	GP025B	Trappola aria	Air trap	Chambre de compression
17	GP025BCOMP	Trappola aria completa	Pressure vessel assy complete	Prise d'air complète

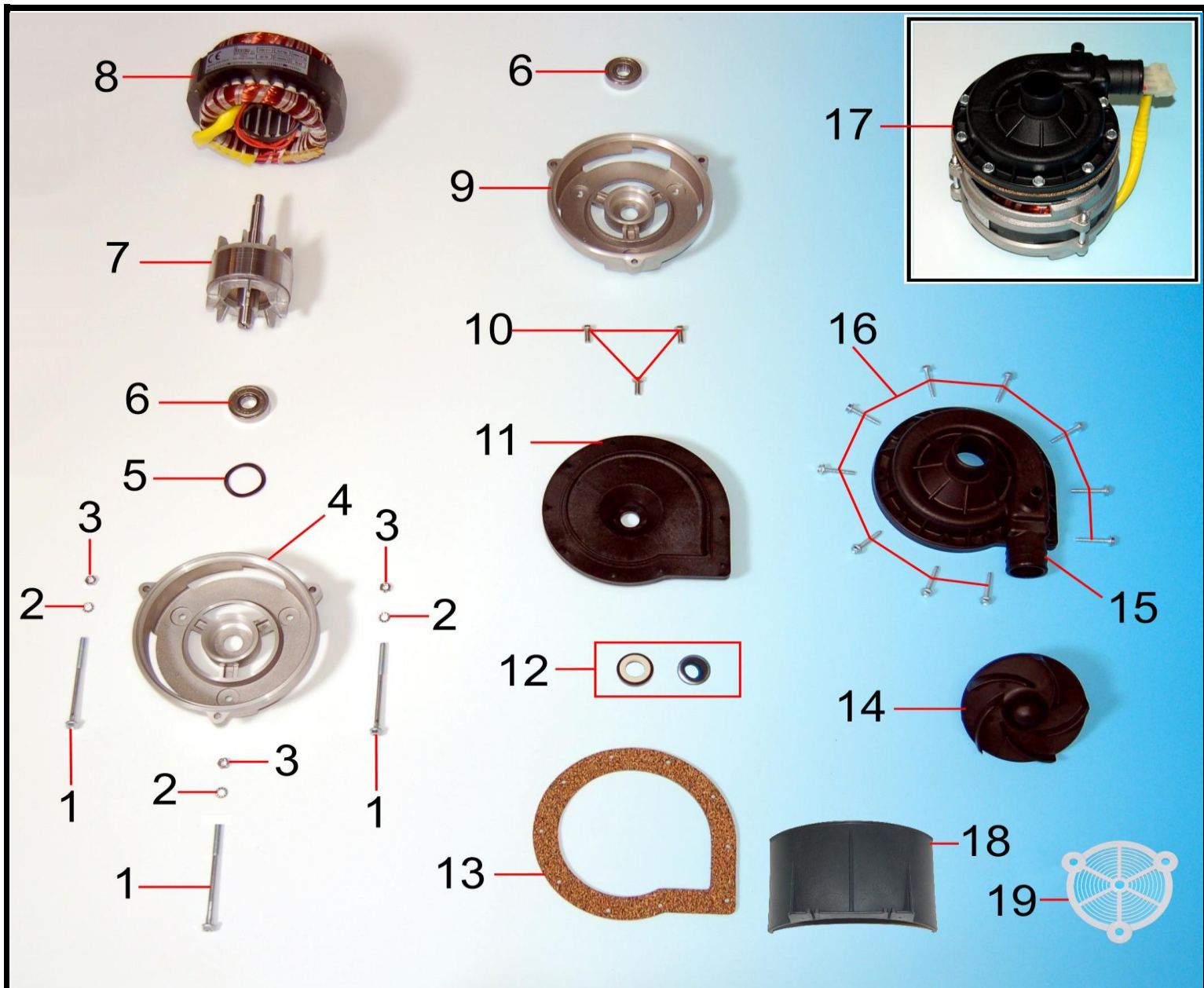

Pos.	Codice	Descrizione	Description	Description
1	VVTE560Z	Vite TE 5x60	Special screw	Vis
2	VR5I	Rondella dentata diametro 5	Special washer	Rondelle éventillé, diam. 5
3	VD5I	Dado esagonale m 5	Special nut	Ecrou M5
4	EP05M5	Calotta alluminio (filettata)	Endplate NDE	Calotte aluminium pompe
5	EP011	Anello compensazione pompa	Bearing ring	Boucle compensation pompe
6	EP07	Cuscinetto per motore pompa	Bearing	Roulement pour moteur pompe
7	EP2589	Rotore con albero	Rotor, 0.3HP	Rotor de compression
8	EP2510	Statore avvolto	Stator, 0.3HP	Stator pompe
9	EP05	Calotta alluminio	Endplate DE	Calotte aluminium pompe
10	VVTE512I	Vite TE 5x12	Special screw	Vis mm 5x12
11	EP255TP	Fondo pompa piccola	Impellor back plate	Fond pompe
12	EP04	Anello tenuta	Rotating seal	Boucle pompe
13	EP252NT	Guarnizione pompa	Cork gasket 0.3HP	Joint pompe
14	EP253	Girante pompa piccola	Impellor, diam. 88 mm	Turbine de pompe, diam. 88mm
15	EP251TP	Corpo pompa piccola	Impellor housing	Corps pompe
16	VATE4225Z	Vite autofilettante 4,2x25	Special screw	Vis 4,2x25
17	EP30	Elettropompa 0,3 hp 230v 50hz	Wash pump complete, 0.3 HP	Pompe de lavage
18	GLPPH25PL	Protezione pompa	Pump protection	Protection pompe
19	AM0GVP	Griglia ventilazione pompa	Pump ventilation grill	Grille protection pompe

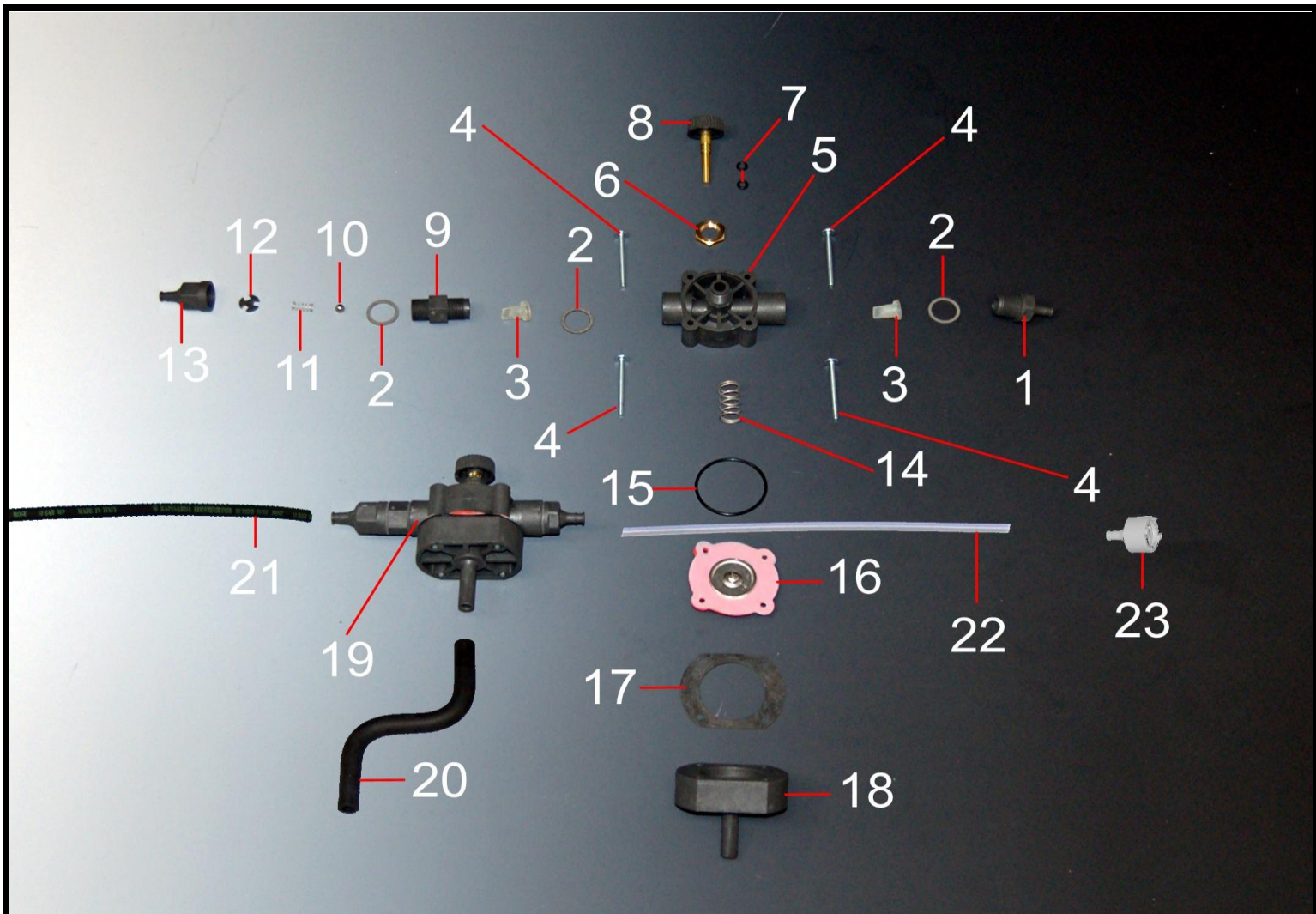

Pos.	Codice	Descrizione	Description	Description
1	DS10NT	Raccordo stringitubo	Inlet nipple	Raccord
2	G16221F	Guarnizione fibra 17x22x1,5	Seal for injector	Joint pour injecteur
3	DS8S	Valvolina silicone	Non return valve, rubber	Soupape en silicone
4	VVTCC445Z	Vite fissaggio	Special screw	Vis serrage
5	DS3	Corpo dosatore	Injector front body	Corps doseur produit de rinçage
6	DS24	Dado 20x4x14	Brass nut 20x4x14	Ecrou 20x4x14
7	OR103	Or 103	O ring 103	Or 103
8	DS1	Volantino dosatore	Adjusting screw	Manette pour doseur
9	DSVNR12	Raccordo valvola non ritorno	Housing for non return valve	Raccord soupape
10	DSVNR13	Sfera 1/4"	1/4" Ball for non return valve	Bille 1/4"
11	DSVNR14	Molla valvola non ritorno	Spring for non return valve	Ressort clapet anti retour
12	DSVNR16	Dischetto valvola non ritorno	Special disk for non return valve	Petit disque clapet anti retour
13	DSVNR17NT	Raccordo stringitubo valvola non ritorno	Outlet nipple	Raccord clapet anti retour
14	DS4	Molla membrana	Spring for diaphragm	Ressort pour membrane
15	OR422	Or 42x2	O ring 42x2	Or 42x2
16	DS06M3	Membrana completa	Diaphragm	Membrane
17	DS15	Guarnizione 64x50x1	Seal 64x50x1 for diaphragm	Joint 64x50x1
18	DS15A	Supporto posteriore	Injector rear body	Support postérieur
19	DSAM3NT	Dosatore brillantante completo assemblato	Rinse aid injector, complete	Doseur produit de rinçage
20	DS227	Tubo dosatore pompa piccola	Injector operating hose, small	Tube, doseur, petite pompe
21	TG510DS	Tubo dosatore 5x10	Rinse aid tube to boiler	Tube doseur 5x10
22	TSIL48	Tubo silicone 4x8	Silicone rinse aid inlet tube	Tube silicone 4x8
23	D0SVFFC	Valvola di fondo con filtro	Foot valve with filter	Clapet avec filtre

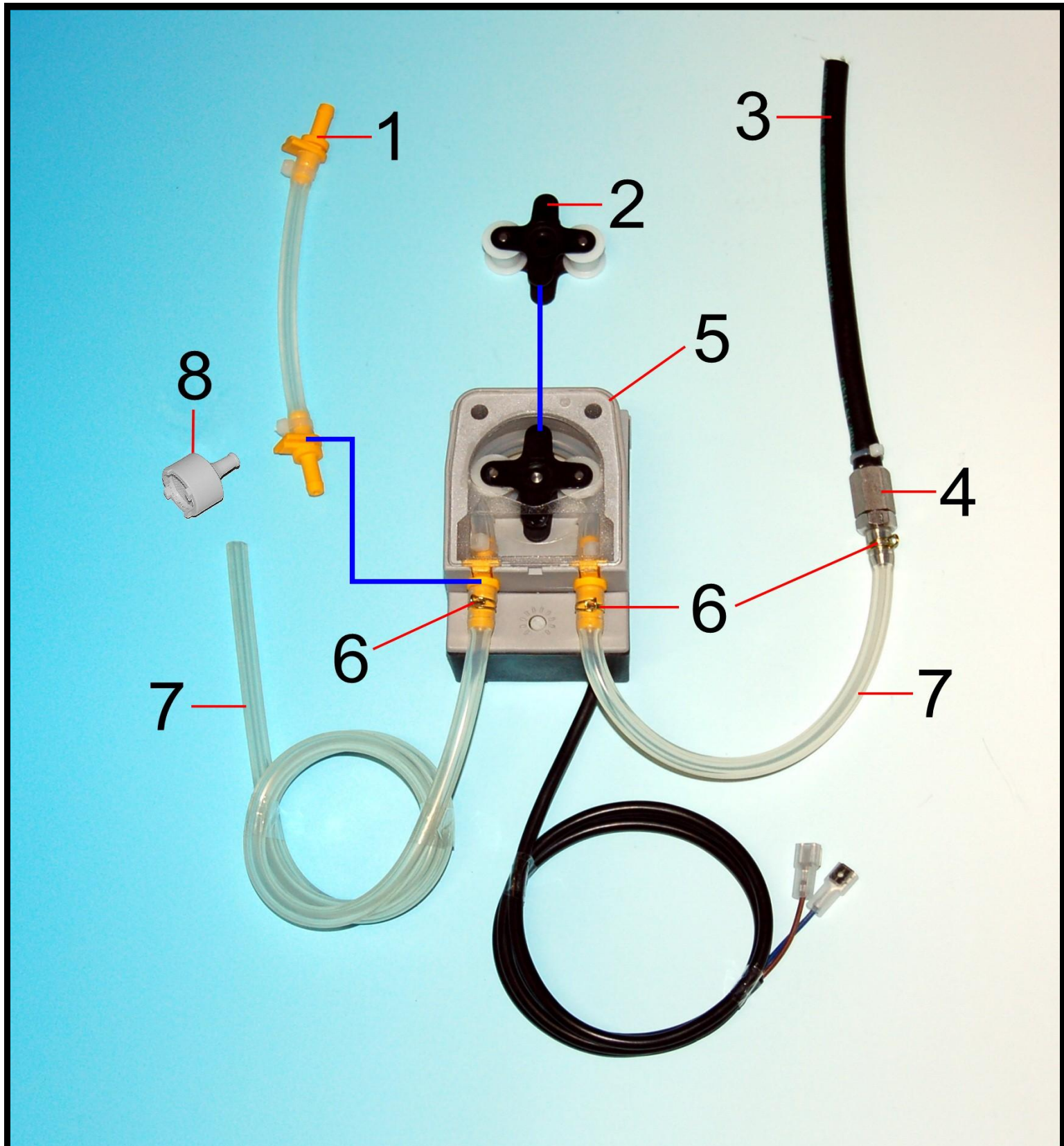

Pos.	Codice	Descrizione	Description	Description
1	D0STSILSKC	Tubo silicone brillantante+attacchi	Peristaltic rinse aid tube with fittings	Tube silicone doseur produit rinçage
2	D0SPRRSKC	Portarullini peristaltica seko	Rotating pump head, rinse aid	Rotor
3	TG510DS	Tubo dosatore 5x10	Rinse aid tube to boiler	Tube doseur 5x10
4	D0SVNRSKC	Valvola non ritorno seko	Non return valve	Clapet anti retour
5	D0SBRIETLE	Dosatore brillantante "eur"	Rinse-aid pump housing	Doseur produit rinçage "eur"
6	FAM710	Fascetta a molla	Wire clip for tube	Collier
7	TSIL48	Tubo silicone 4x8	Silicone rinse aid inlet tube	Tube silicone 4x8
8	D0SVFFC	Valvola di fondo con filtro	Foot valve with filter	Clapet avec filtre

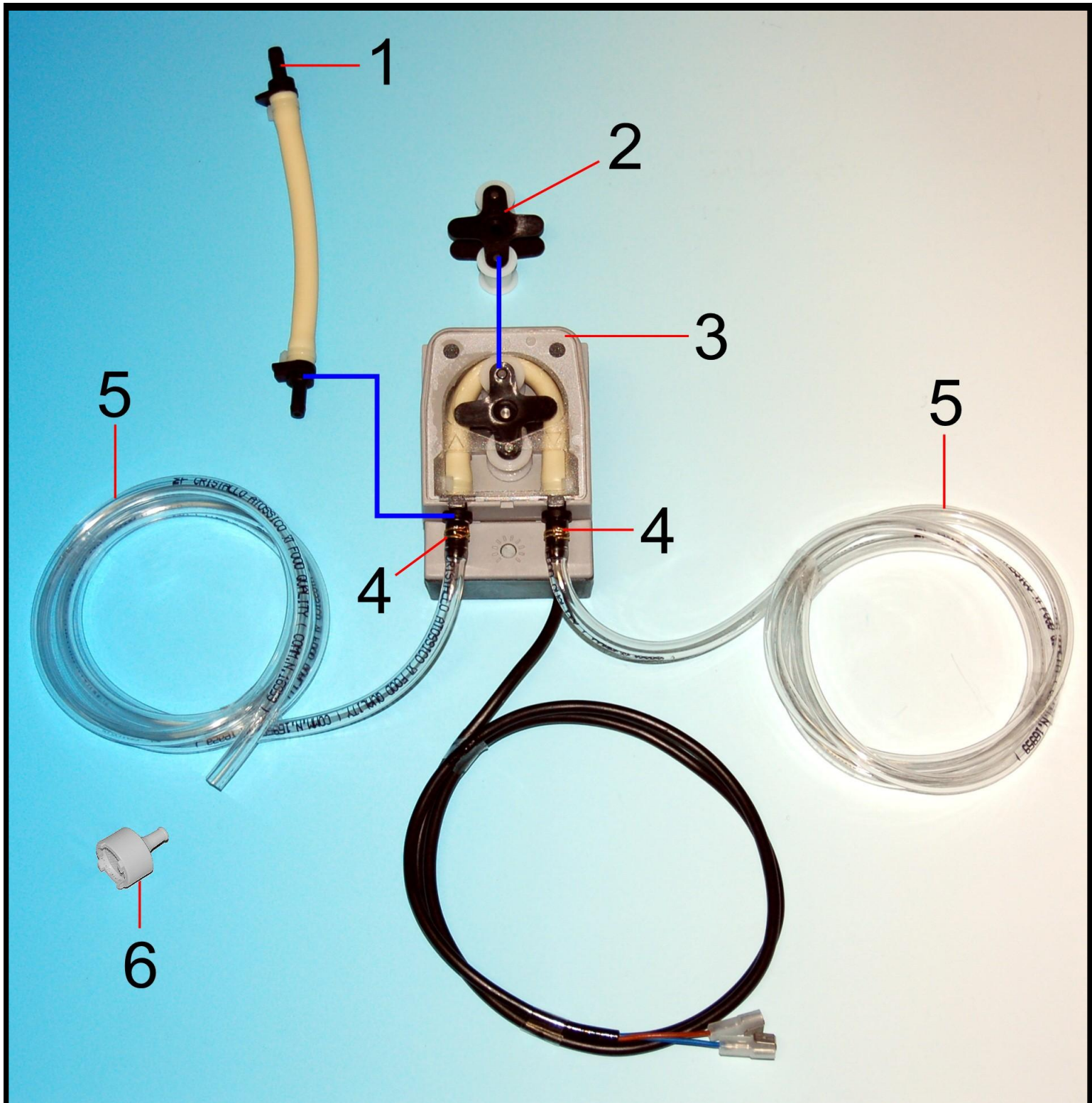

Pos.	Codice	Descrizione	Description	Description
1	D0STSANSKC	Tubo Santoprene detergente+attacchi	Peristaltic soap tube with fittings	Tube Santoprene doseur p. lavage
2	D0SPRRSKC	Portarullini peristaltica seko	Rotating pump head, soap	Rotor
3	D0SDETETLE	Dosatore detergente "eur"	Soap pump	Doseur produit de lavage "eur"
4	FAM710	Fascetta a molla	Spring clip for tubing	Collier
5	TC58	Tubo pvc cristal 5x8	Soap PVC tubing	Tube pvc cristal 5x8
6	D0SVFFC	Valvola di fondo con filtro	Foot valve with filter	Clapet avec filtre

HANDLES

POIGNEES

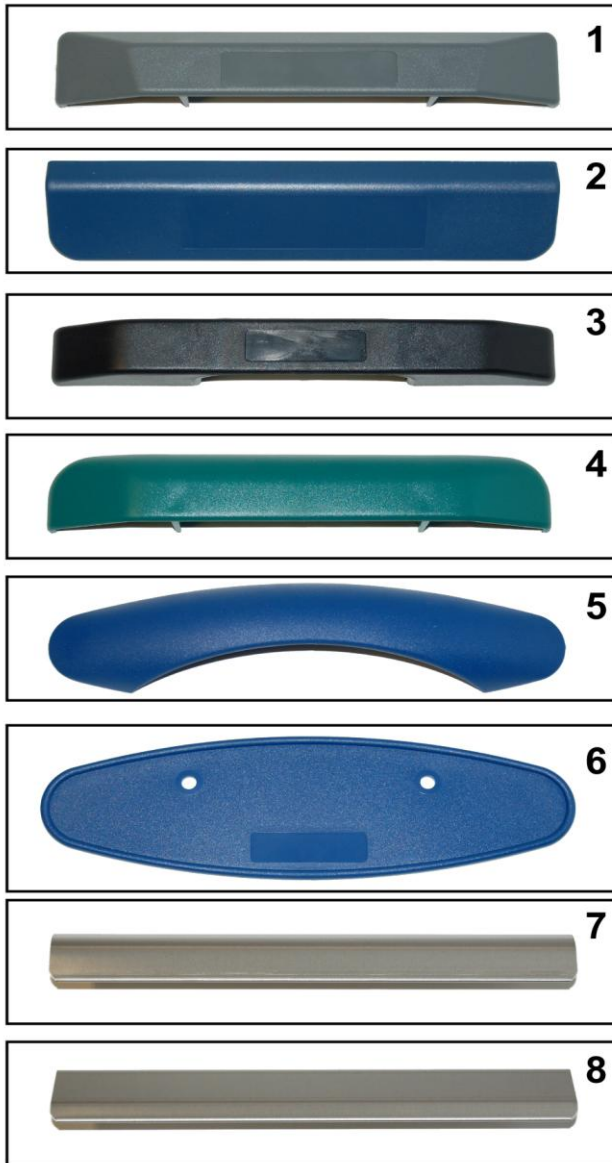

Pos.	Codice	Descrizione	Description	Description
1	AM010GBGR	Maniglia grigia	Handle, grey	Poignée porte grise
2	AM010SIM	Maniglia blu	Handle, blue, closed grip, rectangular	Poignée porte , bleue
3	AM010PA	Maniglia aperta nera	Handle, black, thru grip, angled	Poignée porte noire
4	AM010PCV	Maniglia chiusa verde	Handle, green, closed grip, curved	Poignée porte vert
5	AM010MD25	Maniglia chiusa ovale blu	Handle, blue, thru grip, oval	Poignée porte ovale, bleue
6	AM010CD25	Cornice sottomaniglia blu	Handle backplate, blue, oval	Entourage sous-poignée, bleue
7	AM010F	Maniglia curva inox	Handle, Stainless steel, round section	Poignée porte courbe, inox
8	AM010R	Maniglia poligonale inox	Handle, Stainless steel, angled section	Poignée porte inox inclinée
9	VVSP6100	Vite maniglia	Screw, door handle fixing	Vis pour poignée porte
10	OR106	Or per vite maniglia	O-Ring, door handle screw	Joint torique pour poignée
11	VD6I	Dado M6	Nut, M6	Ecrou, M6
12	AM010SMH	Cornice sottomaniglia nero	Handle backplate, rectangular	Entourage sous-poignée, noire
13	AM010CD25GR	Cornice sottomaniglia grigia	Handle backplate, grey, oval	Entourage sous-poignée, grise
14	AM010MD25GR	Maniglia chiusa ovale grigia	Handle, grey, thru grip, oval	Poignée porte grise
15	AM010SW	Maniglia chiusa nera	Handle, black, thru grip, double curved	Poignée porte noire
16	AM010PC	Maniglia chiusa nera	Handle, black, closed grip, curved	Poignée porte noire
17	AM010PAGR	Maniglia aperta grigia	Handle, grey, thru grip, angled	Poignée porte grise
18	AM010GB	Maniglia blu	Handle, blue	Poignée porte , bleue

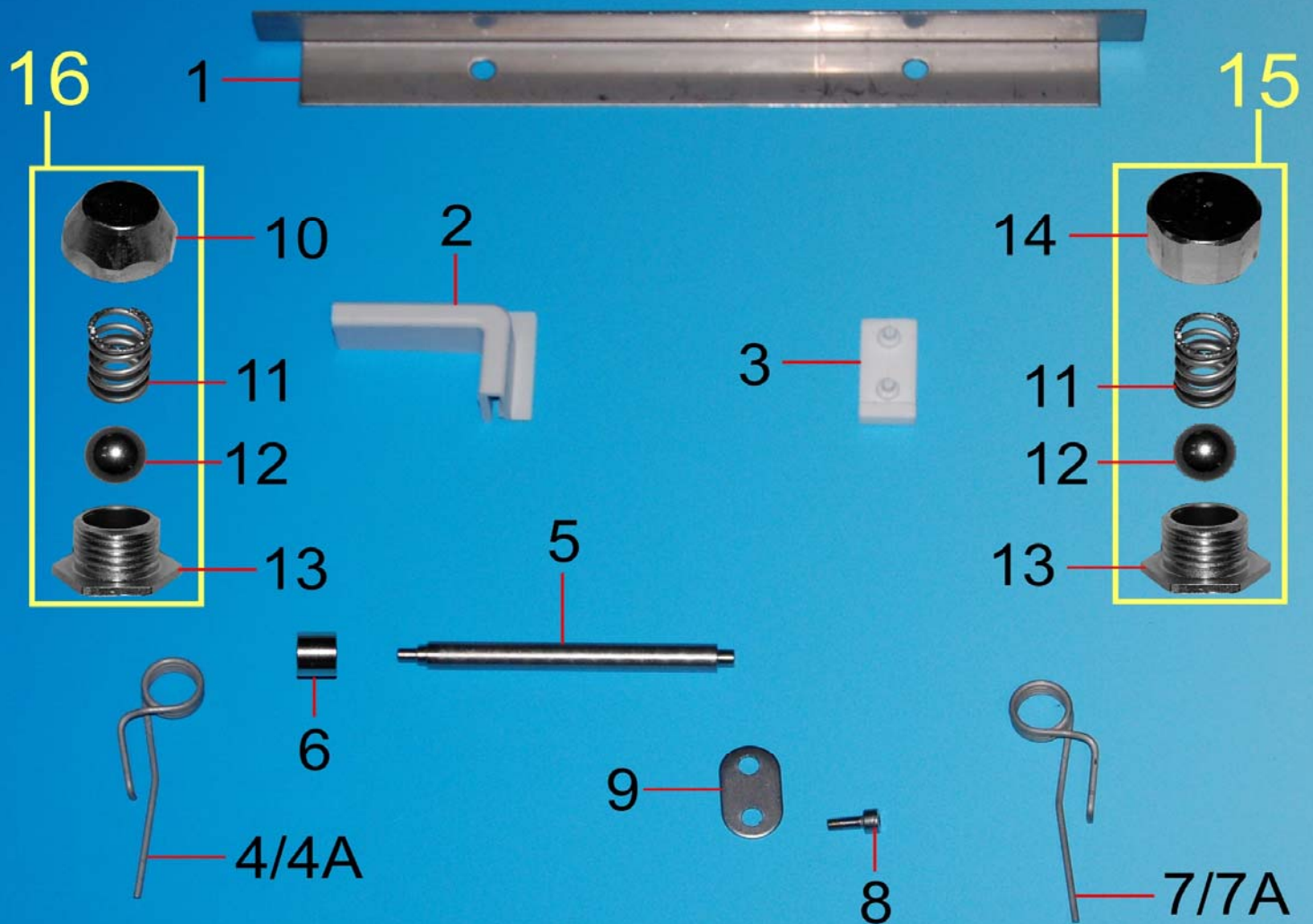

Pos.	Codice	Descrizione	Description	Description
1	GMDP1	Deflettore porta	Door deflector	Deflecteur porte
2	AM014B	Angolare vasca plastica	Plastic corner guard	Coin extérieure, plastique
3	AMPCP	Paracolpo porta	Door stop	Pare-chocs
4	AMMP1DX	Molla destra per porta	Door spring, RH	Ressort droit porte
4A	AMMP1A2DX	Molla destra per porta mod. alta	Door spring, RH	Ressort droit porte, porte haute
5	AM112NTM	Perno porta	Door pin	Axe de la porte
6	AM012M	Distanziale	Door pin spacer	Entretoise
7	AMMP1SX	Molla sinistra per porta	Door spring, LH	Ressort gauche porte
7A	AMMP1A2SX	Molla sinistra per porta mod.alta	Door spring, LH	Ressort gauche porte, porte haute
8	VVEI410I	Vite, 4x10 mm	Screw, 4x10 mm	Vis, 4x10 mm
9	AM0PFPPM	Piastrina fissaggio perno porta	Pin security plate	Plaquette tenue pivot porte
10	AM011AR	Dado scrocchetto vasca raggiata	Ball catch nut, round corners tank	Bouchon de la bille, cuve rayonnée
11	AM011C	Molla scrocchetto	Ball catch spring	Ressort inox
12	AM011D	Sfera scrocchetto	Ball catch ball	Bille inox
13	AM011E	Sede sfera scrocchetto	Ball catch seat	Siège ressort inox
14	AM011A	Dado scrocchetto vasca quadra	Ball catch nut	Bouchon de la bille, cuve carrée
15	AM011	Scrocchetto completo vasca quadra	Door ball catch assy	Fermeture de porte, cuve carrée
16	AM011R	Scrocchetto completo vasca raggiata	Door ball catch assy, round corners	Fermeture de porte, cuve rayonnée

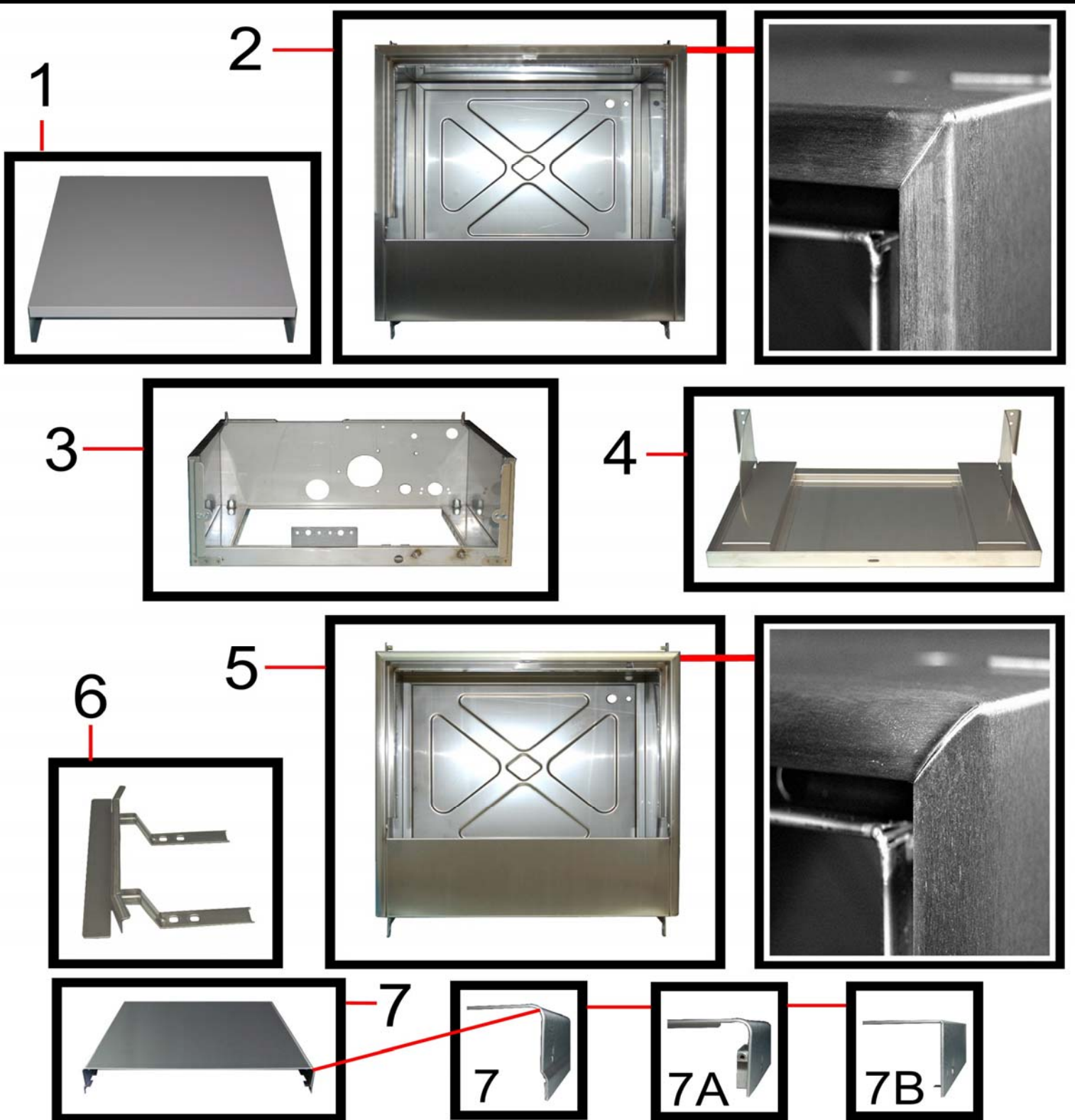

Pos.	Codice	Descrizione	Description	Description
1	GMPP1H65	Pannello posteriore	Back panel	Panneau dosseret
2	GMVA1JSTD	Vasca quadra	Wash cabinet	Cuve
3	GMBA1	Basamento	Base	Socle
4	GMP01M	Porta	Door	Porte
5	GMVA1RJSTD	Vasca raggiata	Wash cabinet, square corners	Cuve
6	GMGCSF1DSXI	Guida dx-sx supporto cestello senza filtri	Basket ramp, right/left without filters	Support panier gauche/droit sans filtres
7	GMPS1RDP	Pannello superiore	Top panel, steel	Panneau supérieur, inox
7A	GMPS1N0S	Pannello superiore	Top panel, steel	Panneau supérieur, inox
7B	GMPS1SIM	Pannello superiore	Top panel, steel	Panneau supérieur, inox

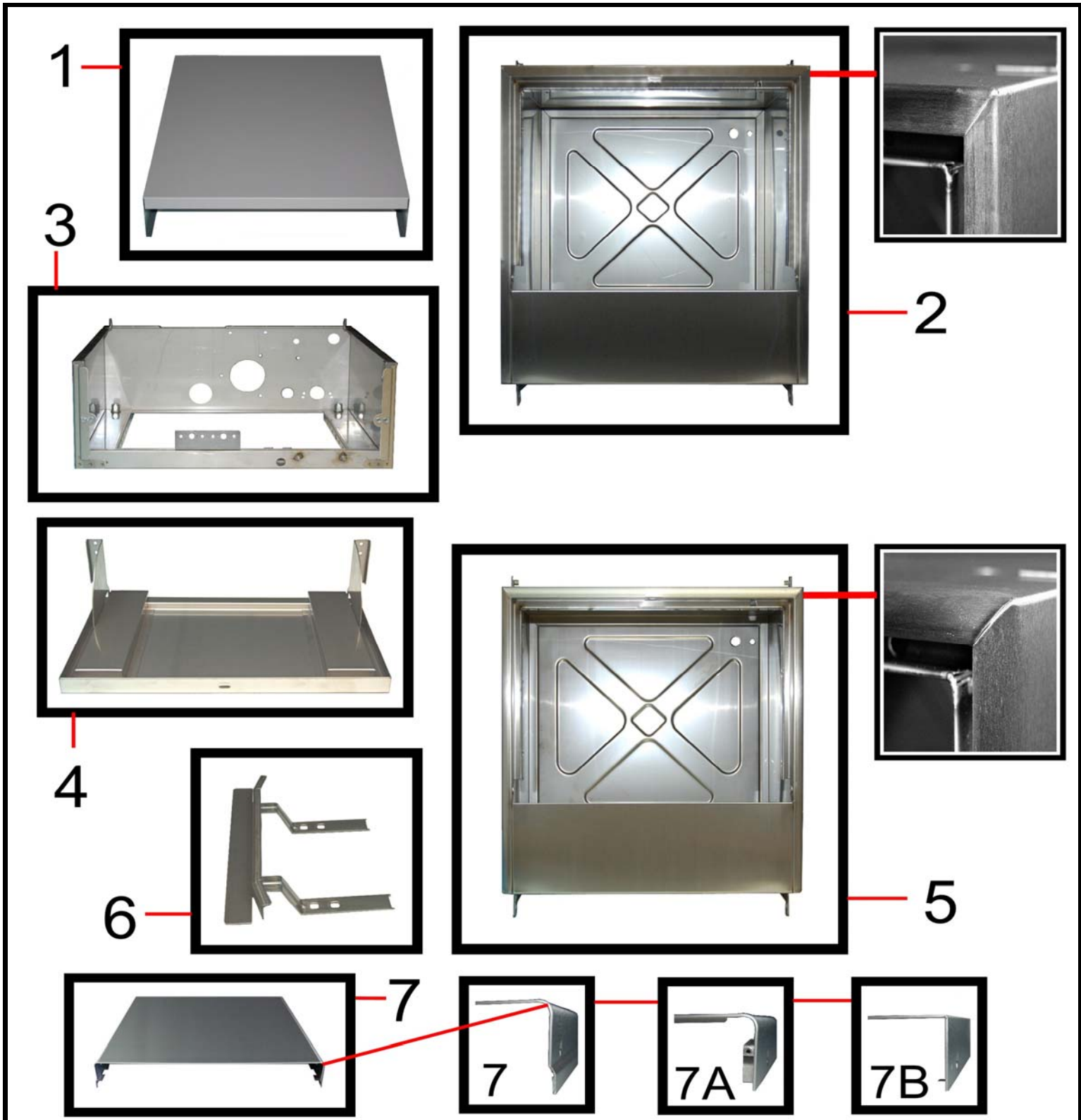

Pos.	Codice	Descrizione	Description	Description
1	GMPP1AH65	Pannello posteriore	Back panel	Panneau dossieret
2	GMVA1AJSTD	Vasca quadra	Wash cabinet	Cuve
3	GMBA1	Basamento	Base	Socle
4	GMP01AM	Porta	Door	Porte
5	GMVA1AJRSTD	Vasca raggiata	Wash cabinet, round corners	Cuve
6	GMGCSF1DSXI	Guida dx-sx supporto cestello senza filtri	Basket ramp, right/left without filters	Support panier, gauche/droit sans filters
7	GMPS1RDP	Pannello superiore	Top panel	Panneau supérieur, inox
7A	GMPS1N0S	Pannello superiore	Top panel	Panneau supérieur, inox
7B	GMPS1SIM	Pannello superiore	Top panel	Panneau supérieur, inox

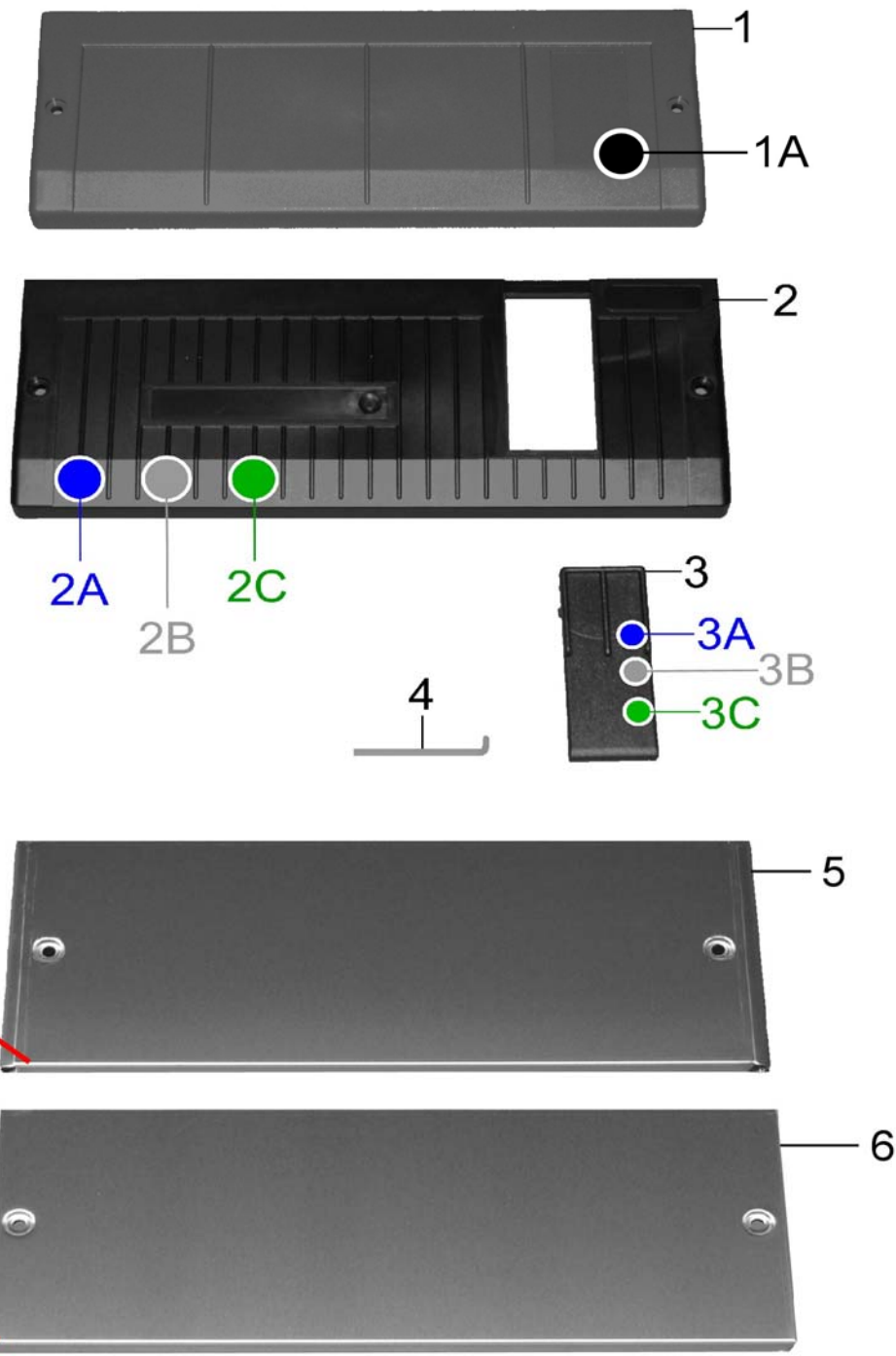

Pos.	Codice	Descrizione	Description	Description
1	GMCR1SCPLGR	Cruscotto grigio senza cava	Bottom panel, grey, plastic	Panneau socle inox, gris
1A	GMCR1SCPLNR	Cruscotto nero senza cava	Bottom panel, black, plastic	Panneau socle inox, noir
2	GMCR1CPL	Cruscotto nero con cava	Bottom panel, plastic	Panneau socle plastique, noir
2A	GMCR1CPLBL	Cruscotto blu con cava	Bottom panel, blue, plastic, aperture	Panneau socle inox, bleu
2B	GMCR1CPLGR	Cruscotto grigio con cava	Bottom panel, grey, plastic, aperture	Panneau socle inox, gris
2C	GMCR1CPLV	Cruscotto verde con cava	Bottom panel, green, plastic, aperture	Panneau socle inox, vert
3	AM0TCBPL	Tappo cava nero	Plastic cover for r/a opening, black	Bouchon, noir
3A	AM0TCBPLB	Tappo cava blu	Plastic cover for r/a opening, blue	Bouchon, bleu
3B	AM0TCBPLGR	Tappo cava grigio	Plastic cover for r/a opening, grey	Bouchon, gris
3C	AM0TCBPLV	Tappo cava verde	Plastic cover for r/a opening, green	Bouchon, vert
4	AM029	Spina fissaggio inox	Securing rod for r/a reservoir	Bonde fixation inox
5	GMCR1SCR	Cruscotto inox senza cava raggiato	Bottom panel, steel	Panneau socle inox
6	GMCR1SC	Cruscotto inox senza cava quadro	Bottom panel, steel	Panneau socle inox

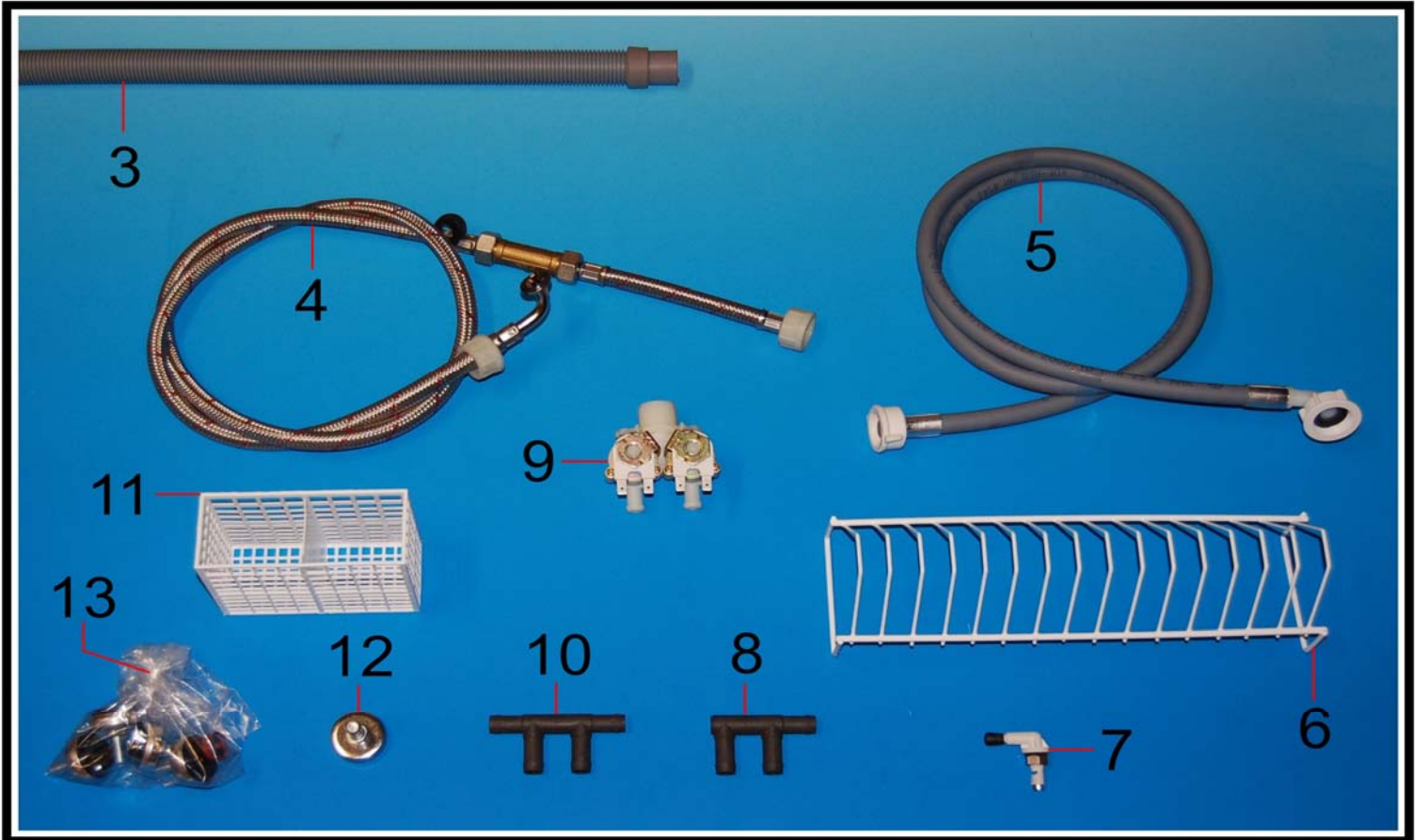

Pos.	Codice	Descrizione	Description	Description
1	CQ3516LPL	Cestello 35x35x16	Glass basket 35cm square plastic	Panier 35x35x16
2	CT3617PL2	Cestello Ø 36x17	Round basket plastic 36x17	Panier Ø 36x17
3	GS130	Tubo scarico Ø 25	Drain Pipe Diam 25	Tuyau de vidange Ø 25
4	VDCVGB	Doppia valvola con tubo carico	Water Supply Hose+DbI Chk Valve,1,5m	Double valve avec tuyau entrée eau
5	TC3415	Tubo carico "vde" mt. 1,5	Water Supply Hose, 3/4" BSP, 1,5 m	Tuyau entrée eau "vde" mt. 1,5
6	CTIP15	Inserto porta piattini 15 posti	Small saucer rack	Godet porte soucoupes (15)
7	DSDET040BC	Iniettore completo	Soap Elbow Assy	Injecteur completo
8	GB017NT	Portagomma a "L" 1 via	3 Way Connector	Raccord à "L" 1 voie
9	CEEV2	Elettrovalvola 2 vie 220 volt	Solenoid Valve, 2-Way, 230V	Electrovanne 2 voies 220 volt
10	GB055	Portagomma a "T" 2 vie	Double Tee Connector	Raccord à "T" 2 voies
11	IP2PP	Inserto porta posate piccolo	Small cutlery basket	Godet porte couverts petit
12	AM016NT	Piedino regolabile lavabicchieri	Adjustable foot - glasswashers	Pied réglable - lave verres
13	AM016NTC	Confezione 4 piedini lavabicchieri	Set of 4 adjustable feet glasswashers	Set nr.4 pieds laveverres

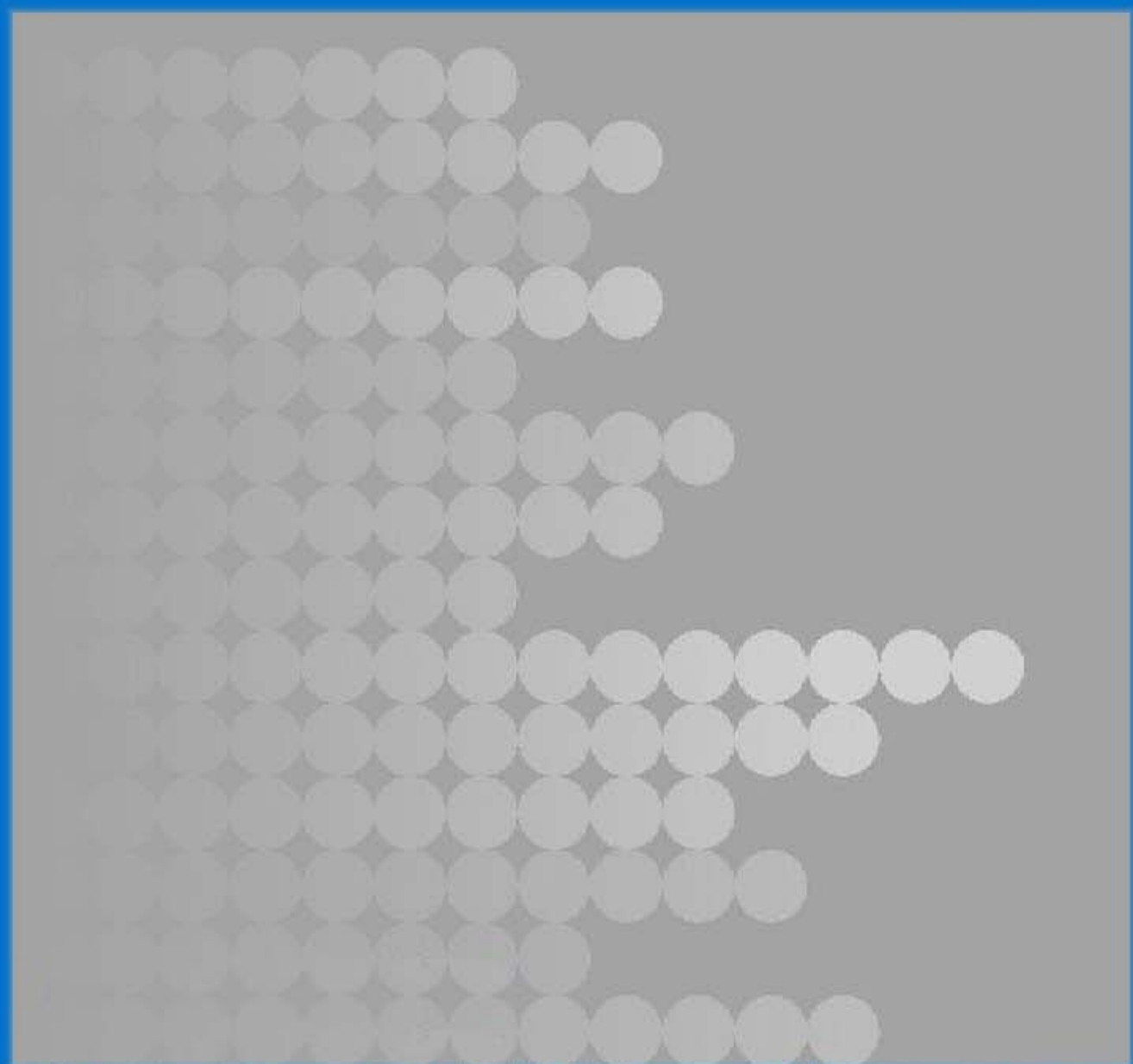

0508/102.02

